

AN  
EXPERIMENT  
WITH  
TIME

▼  
J.W.DUNNE.

SECOND  
EDITION

BLACK

AN EXPERIMENT WITH TIME

**AGENTS**

- AMERICA** . . . . THE MACMILLAN COMPANY  
60 FIFTH AVENUE, NEW YORK
- AUSTRALASIA** . . . OXFORD UNIVERSITY PRESS  
205 FLINDERS LANE, MELBOURNE
- CANADA** . . . . THE MACMILLAN COMPANY OF CANADA, LTD.  
ST. MARTIN'S HOUSE, 70 BOND STREET, TORONTO. 2
- INDIA** . . . . . MACMILLAN AND COMPANY, LTD.  
276 HORNBY ROAD, BOMBAY  
294 BOW BAZAR STREET, CALCUTTA  
NORTH BEACH ROAD, MADRAS

AN  
EXPERIMENT  
WITH TIME

BY  
J. W. DUNNE

SECOND EDITION



A. & C. BLACK, LTD.  
4, 5 & 6 SOHO SQUARE, LONDON, W. 1

1929



*Printed in Great Britain.*

## CONTENTS

	PAGE
PART I	
DEFINITIONS - - - - -	I
PART II	
THE PUZZLE - - - - -	29
PART III	
THE EXPERIMENT - - - - -	49
PART IV	
TEMPORAL ENDURANCE AND TEMPORAL FLOW - -	91
PART V	
SERIAL TIME - - - - -	123

*First published in March, 1927*  
*Second Edition published in 1929*

## NOTE ON THE SECOND EDITION

*The reader will find on page viii an extract from a letter written by Professor A. S. Eddington, the distinguished mathematical-physicist and Relativist.*

\* \* \* \* \*

*As first published, "An Experiment with Time" contained one or two unimportant and very obvious typographical errors. These have been corrected. In addition, a few slight changes have been made in the text proper; but these, as will be seen from the subjoined list, serve merely to accentuate—without modifying—the meanings of the several sentences concerned.*

Page 25, line 26: "Association between the images" is altered to "Association between the dream-images."

Page 36, line 20: "supposed" is altered to "declared."

Page 36, line 32: "4,000" is altered to "arrangement of fours and noughts."

Page 133, line 31: "any such motion" is altered to "any appearance of motion to any observer."

Page 137, line 9: "The movements" is altered to "The to-and-fro movements."

Page 137, line 12: "for observation" is altered to "for such observation."

Page 143, line 26: "our ultimate observer" means, as the context shows, "the ultimate observer we are hunting down." It was, however, taken by one critic to mean "the observer of us." For this reason "our" is altered to "the."

Page 149, line 7: "form planes" is altered to "form vertical planes."

Page 149, line 10: "similar" is deleted.

Page 198, line 7: "upwards in" is altered to "upwards and downwards in"; "upon" is altered to "from."

*Explanatory footnotes have been added to pages 107, 116, and 198. The last of these is the only one of real interest.*

*The short concluding section of Chapter XXIV. has been italicized. It is of considerable importance to the proper understanding of the theory, and it seems to have been frequently overlooked.*

\* \* \* \* \*

*It has been rather surprising to discover how many persons there are who, while willing to concede that we habitually observe events before they occur, suppose that such prevision may be treated as a minor logical difficulty, to be met by some trifling readjustment in one or another of our sciences or by the addition of a dash of transcendentalism to our metaphysics. It may well be emphasized that no tinkering or doctoring of that kind could avail in the smallest degree. If prevision be a fact, it is a fact which destroys absolutely the entire basis of all our past opinions of the universe. Bear in mind, for example, that the foreseen event may be avoided. What, then, is its structure?*

*I would suggest that we are lucky, on the whole, to be able to replace our vanished foundations by a system so simple as the "serialism" described in this book.*

*Anyone who hopes to discover an explanation even simpler would be well advised to examine his own statement of the difficulty to be faced—viz., that we "observe events before they occur." Let him ask himself to what time-order does that word "before" refer. Certainly not to the primary time-order in which the occurring events are arranged! He may see then that his statement (and every expression of his problem must bear that same*

*general form) is in itself a direct assertion that Time is serial.*

*If Time be serial, the universe as described in terms of Time must be serial, and the descriptions, to be accurate, must be similarly serial—as suggested in Chapter XXV. If that be the case, the sooner we begin to recast physics and psychology on such lines, the sooner may we hope to reckon with our present discontinuities and set out upon a new and sounder pathway to knowledge.*

J. W. DUNNE.

*Extract (by permission) from a letter written by Professor A. S. Eddington. ("Minkowski's world," referred to therein, is the "space-time" world adopted by Einstein for the purpose of his theory.)*

"I agree with you about 'serialism'; the 'going on of time' is not in Minkowski's world as it stands. My own feeling is that the 'becoming' is really there in the physical world,\* but is not formulated in the description of it in classical physics (and is, in fact, useless to a scheme of laws which is fully deterministic).

"Yours truly,

"A. S. EDDINGTON.

"OBSERVATORY,  
"CAMBRIDGE,  
"1928, Feb. 1."

\* AUTHOR'S NOTE.—This, I think, no Serialist can deny. The inclined line  $O'O''$  in Fig. 9 is, clearly, as objective to the observer as are any of the vertical lines in that diagram. The fact seems to be that what is abstract or mental to the first-term observer is concrete or physical to him in his second-term outlook.

# AN EXPERIMENT WITH TIME

## PART I

### CHAPTER I

It might, perhaps, be advisable to say here,—since the reader may have been glancing ahead,—that this is not a book about “occultism,” and not a book about what is called “psycho-analysis.”

It is merely the account of an extremely cautious reconnaissance in a rather novel direction,—an account presented in the customary form of a narrative of the actual proceedings concerned, coupled with a statement of the theoretical considerations believed to be involved,—and the dramatic, seemingly *bizarre* character of the early part of the story need occasion the reader no misgivings. He will readily understand that the task which had to be accomplished at that stage was the “isolating” (to borrow a term from the chemists) of a single, basic fact from an accumulation of misleading material. Any account of any such process of separation must contain, of course, some description of the stuff from which the separation was effected. And such stuff very often is, and in this case very largely was—rubbish.

The fact which has emerged in the present instance is precisely what, on theoretical grounds, we should have expected to find. It fits very nicely into its little niche in the system of knowledge; and



it seems, moreover, to possess the attribute against which nothing can ever permanently contend—the attribute of being clearly and directly observable by everyone interested. It is hoped that the present reader will take steps to satisfy himself upon this point.

\* \* \* \* \*

There does not appear to be anything in these pages that anyone is likely to find difficult to follow, provided that he avoids those occasional paragraphs in smaller print which have been written more particularly for specialists. And Part V. may require reading twice. But there are a few commonplace semi-technical expressions which will crop up now and again; and it is always possible that other people may be accustomed to attach to these words meanings rather different to those which the present writer is hoping to convey. Any such misunderstanding would result, obviously, in our being at cross-purposes throughout the greater part of the book. Hence it might be advisable for us to come to some sort of rough preliminary agreement, not as to how these terms ought rightly to be employed, but as to what they are to be regarded as *meant* to mean in this particular volume. By so doing we shall, at any rate, avoid that worst of all irritations to a reader—a text repeatedly interrupted by references to footnote or glossary.

That the agreement will be entirely one-sided will make it all the easier to achieve.

## CHAPTER II

BRIEFLY, then :

Let us suppose that you are entertaining a visitor from some country where the inhabitants are all born blind; and that you are trying to make your guest understand what you mean by "seeing." You discover, we will further assume, that the pair of you have, fortunately, this much in common: You are both thoroughly conversant with the meanings of all the technical expressions employed in the physical sciences.

Using this ground of mutual understanding, you endeavour to explain your point. You describe how, in that little camera which we call the "eye," certain electro-magnetic waves radiating from a distant object are focussed on to the retina, and there produce physical changes over the area affected; how these changes are associated with currents of "nervous energy" (possibly electrical) in the criss-cross of nerves leading to the brain-centres, and how molecular or atomic changes at those centres suffice to provide the "seer" with a registration of the distant object's outline.

All this your visitor could appreciate perfectly.

Now, the point to be noticed is this. Here is a piece of knowledge concerning which the blind man had no previous conception. It is knowledge which he cannot, as you can, acquire for himself by the ordinary process of personal experiment. In substitution, you have offered him a *description*, framed in the language of physical science. And that substitute has served the purpose of conveying the knowledge in question from yourself to him.

But in "seeing" there is, of course, a great deal more than mere registration of outline. There is, for example—Colour.

So you continue somewhat on the following lines. That which we call a "red" flame sets up electromagnetic waves of a certain *length*: a "blue" flame sets up waves exactly similar save only that they differ slightly in this matter of length. The visual organs are so constituted that they sort out waves showing such disparity in length, and this in such a way that these differences are finally registered by corresponding differences in those physical changes which occur at the brain centres.

From the point of view of your blind guest, this description, also, would be entirely satisfactory. He could now understand perfectly how it is that a physical brain is able to register wave-length-difference. And, if you were content to leave it at that, he would depart gratefully convinced that the language of physics had again proved equal to the task, and that your description in physical terms had equipped him with a knowledge of, for instance, what other people call "red" as complete in every respect as that which they themselves possess.

But this supposition of his would be absurd. For concerning the existence of one very remarkable characteristic of red he would still, obviously, know nothing whatsoever. And that characteristic (possibly the most puzzling, and certainly the most obtrusive of them all) is—its *redness*.

*Redness?* Yes. Without bothering about whether redness be a thing or a quality or an illusion or anything else, there is no escaping the fact (1) that it is a characteristic of red of which you and all seeing people are very strongly aware, nor the further fact (2) that your visitor, so far, would have not the

faintest shadow of an idea that you or others experience anything of the kind, or, indeed, that there could exist anything of the kind to be experienced. If, then, you intend to complete your self-imposed task of bringing his knowledge on the subject of "seeing" up to the same level as your own, there remains yet another step before you.

Realizing this, you mentally glance down your list of physical expressions, and—a moment's inspection is enough to show you that, for the purpose of conveying to your blind guest a description of *redness*, there is not a single one of these expressions which is of the slightest use whatsoever.

You might talk to him of particles (lumps,—centres of inertia), and describe these as oscillating, spinning, circling, colliding, and rebounding in any kind of complicated dance you cared to imagine. But in all that there would be nothing to introduce the notion of *redness*. You might speak of waves—big waves, little waves, long waves, and short waves. But the idea of *redness* would still remain unborn. You might hark back to the older physics, and descant upon forces (attractions and repulsions), magnetic, electrical, and gravitational; or you might plunge forward into the newer physics, and discourse of non-Euclidean space and Gaussian co-ordinates. And you might hold forth on such lines until exhaustion supervened, while the blind man nodded and smiled appreciation; but it is obvious that, at the end of it all, he would have no more suspicion of what it is that (as Ward puts it) "you immediately experience when you look at a field poppy" than he had at the outset.

Physical description cannot here provide the information which experience could have given.

Now, redness may not be a thing—but it is very

certainly a *fact*. Look around you. It is one of the most staring facts in existence. It challenges you everywhere, demanding, clamouring to be accounted for. *And the language of physics is fundamentally unadapted to the task of rendering that account.*

It is obvious that dubbing redness an "illusion" would not help the physicist. For how could physics set about describing or accounting for the entry of the element of *redness* into that illusion? The universe pictured by physics is a colourless universe, and in that universe all brain-happenings, including "illusions," are colourless things. It is the intrusion of Colour into that picture, whether as an illusion or under any other title, which requires to be explained.

Once you have thoroughly realized that redness is something beyond a complex of positions, a complex of motions, a complex of stresses, or a mathematical formula, you will have little difficulty in perceiving that Colour is not the only fact of this kind. If your hypothetical visitor were deaf, instead of blind, you could never, by giving him books of physics to read, arouse in him even the beginning of a suspicion regarding the nature of "Sound," as *heard*. Now, Sound, as heard, is a fact: (put down this book and listen). But in the world described by physics there is no such fact to be found. All that physics can show us is an alteration in the *positional arrangement* of the brain particles, or alterations in the *tensions* acting upon those particles. And in no catalogue of the magnitudes and directions of such changes could there be anything to suggest that there exists anywhere in the universe a phenomenon such as that which you directly experience when a bell tolls. In fact, just

as physics cannot deal with the element of redness in "red," so is it inherently unable to account for the intrusion of that clear bell-note into a universe which it can picture only as an animated diagram of groupings, pushings, and pullings.

But if, in such a diagram, there can be nothing of either Colour or Sound, is it likely to be of any use our hunting therein for phenomena like "Taste" and "Smell"? The utmost that we could hope to find would be those movements of the brain-particles which *accompany* the experiences in question; or, possibly, some day, the transference equations relating to some hitherto unsuspected circuit of energy. Your hypothetical visitor and yourself might each possess the fullest possible knowledge of these brain-disturbances, the most complete acquaintance with such energetic equations as may still remain to be written; but, if you could actually taste and smell, and he could not, it is incontrovertible that your knowledge of each of these phenomena would include something quite unknown to, and, indeed, quite unimaginable by, him.

Now, when we say of any occurrence that it is "physical," we mean thereby that it is potentially describable in physical terms. (Otherwise the expression would be wholly meaningless.) So it is perfectly correct to state that, in every happening with which our sensory nerves are associated, we find, *after* we have abstracted therefrom every known or imaginable physical component, certain categorically non-physical *residua*.

But these remnants are the most obtrusive things in our universe. So obtrusive that, aided and abetted by our trick of imagining them as situated at our outer nerve-endings, or as extending beyond those endings into outer Space, they produce the



effect of a vast external world of flaming lights and colours, pungent scents, and clamorous, tumultuous sounds. Collectively, they bulk into a most amazing tempest of sharply-differentiated phenomena. And it is a tempest which remains to be considered *after* physics has completed its say.

PHYSICS.—Nor is this last a matter for wonderment. For the ideal object of physics is to seek out, isolate, and describe such elements in Nature as may be credited with an existence independent of the existence of any immediate observer. Physics is, thus, a science which has been expressly designed to study, not the universe, but the things which would supposedly remain in that universe if we were to abstract therefrom every effect of a purely sensory character. From the very outset, then, it renounces all interest in such matters as those colours, sounds, etc., of which we are directly aware,—matters essentially dependent upon the presence of an immediate observer, and non-existent in his absence,—and it limits itself to a language and a set of conceptions serviceable only for the description of facts pertaining to its own restricted province.

PSYCHOLOGY AND PSYCHICAL.—But, as scientific investigators of the situation in which we find ourselves, we cannot, of course, neglect to study a mass of phenomena so large and so obtrusive as to constitute, to first appearance, the whole of the world we know. Consequently, a separate science has gradually arisen which endeavours to deal with these and other of the rather bulky leavings of physics. This science is called "*Psychology*," and the facts with which it deals—facts existing only in the presence of an immediate observer—are dubbed "mental," or, more commonly, "Psychical."

### CHAPTER III

Now, although it is scientifically indisputable that the brain, regarded as a purely physical piece of mechanism, cannot create, unassisted and out of nothingness, any of those vivid psychical appearances we call "colour," "sound," "taste," etc., it may be taken as experimentally established that these phenomena do not come into existence unless accompanied by some stimulation of the corresponding sense organs. Moreover, they vary in character according to the character of the sense organ involved: lights and colours accompany activities of the optic nerves; sounds are associated with the existence of ears; tastes with palates. The psychical phenomena are different *because* the sensory organizations are different. Colour experiences in man range from violet to deep red, according to the wave-lengths of the electro-magnetic rays impinging upon the eye. If that wave-length be further slightly increased, the associated psychical experience is one of heat alone. But we know that, with a very little modification of the sensitive optical elements involved, those heat experiences would be accompanied by experiences of a visible infra-red colour.

Thus, the physical brain, though it cannot create such sensory appearances, is a prime factor in their *characterization*, and, for that reason, an important factor in whatever process it may be that causes them to appear.

The situation, thus far, is usually summed up in the cautious statement that these particular kinds of

psychical phenomena, on the one hand, and their corresponding sense-organ stimulations, on the other, invariably accompany one another, or run, so to say, on parallel tracks in Time. This, be it noted, is never advanced as an "explanation": it is merely supposed to be a simple way in which the facts can be announced without dragging in the various metaphysical creeds favoured by the various announcers.

PSYCHONEURAL PARALLELISM.—The assumption that this "parallelism" of psychical and neural (nervous) events extends to *all* observable thought-experience—that there is no observable psychical activity without some corresponding activity of brain—is called "*Psychoneural Parallelism*"; the activity in either class being referred to as the "correlate" of that in the other.

The accumulated evidence in favour of this view is practically overwhelming. Hard thinking induces brain fatigue; drugs which poison the brain interfere with our reasoning processes; brain deterioration affects our ability to form new memories. Above all, "concussion" of the brain appears to destroy all memory of the events which immediately *preceded* the accident—indeed, it is by the failure of the patient to remember what led up to that accident that the physician diagnoses concussion. This provides us with almost indisputable evidence that the means of remembering are "brain-traces" which *require a little time for their assured establishment*.

That such brain-traces (insulated paths formed by the passage of nervous currents) do, in fact, exist, is well known; and, moreover, it has been shown that the greater the ability of the individual to perform associative thinking, the more numerous

and the more complex in their ramifications are the brain paths in question.

OBSERVER.—We have now arrived within introductory range of that very meek-spirited creature known to modern science as the "*Observer*." It is a permanent obstacle in the path of our search for external reality that we can never entirely get rid of this individual. Picture the universe how we may, the picture remains of our making. On the other hand, it is, probably, equally true that, paint the picture how we will, we have to do it with the paints provided. But there is no reason why either of these limitations should invalidate the result regarded as a *map* by which we may safely set our course. Moreover, we can test it in that respect; and experience has shown that, thus tested, it proves reliable. Therein lies the justification of our search for knowledge.

It is worth noting that, from the study of a picture, we may always infer a little about the character and situation of the unincluded artist. Science, indeed, is often obliged to decide that certain changes or peculiarities in what is observed are only to be accounted for by inferring changes or peculiarities in the observer.

The general procedure, however, in every science, is to begin by the accurate tabulating of differences in what is observed. If we subsequently discover that these differences are due to the character or actions of the observer, we can note that such is the explanation of the difference and draft our science accordingly; but that addition to our knowledge does not invalidate our previous analysis of the differences as observed.

All sciences deal only with a *standard* observer, unless the contrary is explicitly stated; and

psychology is no exception to this rule. Its observer is assumed to be any normally constituted individual. And this individual is the same observer as is ultimately employed in physics. In what the psychologist says about the colours of "after-impressions," and in what the physicist says about the "spectra" of certain stars, this same standard observer is implicated. And it is assumed that he is not colour-blind.

Now, it must be admitted that the tenets of psychoneural parallelism are not very encouraging to this "observer." For they suggest that, when the brain-workings come to an end, the psychical phenomena cease likewise from troubling. Moreover, the scientific procedure of pushing the observer as far back as possible—so as to get as much as possible of the picture into the category of that which is observed—tends to reduce him to the level of a helpless onlooker with no more capacity for interference than has a member of a cinema audience the ability to alter the course of the story developing before him on the screen. Nor is there much more comfort to be obtained from a study of the various metaphysical interpretations (none of them offer an *explanation*) of this parallelism of Mind and Body. Idealist and Realist may dispute hotly as to precisely how far the observer colours, so to say, the phenomena which he observes; but decisions arrived at in that respect need not suggest that he has any power of changing either the colouring he confers or the thing perceived as thus coloured—much less the ability to continue observing when there is no longer any brain activity to be observed.

ANIMISM.—In this connection, however, we must recognize the existence of a small but very vigorous

group of philosophers known as "*Animists*." In this twentieth century the leading exponent of *Animism* is indubitably Professor William McDougall, whose book, "*Body and Mind*," sets out the arguments for and against the theory with scrupulous fairness. Indeed, I cannot call to mind anyone who has stated the case against Animism with such devastating force.

Animism holds that the observer is anything but a nonentity. He is no "conscious automaton." He may, indeed, stand right outside the pictured universe; but he is a "soul," with powers of intervention which enable him to alter the course of observed events—a mind which not only reads the brain, but which employs it as a tool. Much as the owner of an automatic piano may either listen to its playing or play on it himself.

The inference is that this observer can survive the destruction of that brain which he observes. As for his intervention, there is no insuperable objection to that from the physical side. McDougall quotes and suggests various ways in which intervention could be effected without adding to or subtracting from the amount of energy in the nervous system.

The man-in-the-street is always at a loss to understand why the great majority of men of science are so coldly opposed to the idea of a "soul." The religious man in particular cannot comprehend why his arguments should arouse not merely opposition, but bitter contempt. Yet the reason is not far to seek. It is not that the idea is attributed to man's inordinate conceit (though this is sometimes done by the unreflecting); for, all said and done, a navy who can walk into a public-house and order a pot of beer is an infinitely more wonderful thing than



is the biggest lump of cooling mud that ever swam in the skies. But there can be no reasonable doubt that the idea of a soul must have first arisen in the mind of primitive man as the result of observation of his dreams. Ignorant as he was, he could have come to no other conclusion but that, in dreams, he left his sleeping body in one universe and went wandering off into another. It is considered that, but for that savage, the idea of such a thing as a "soul" would never have even occurred to mankind; so that arguments subsequently introduced to bolster up a case thus *tainted at its source* can have no claim to anyone's serious attention.

*But why tainted?*

*The "deep sleep" of Adam caused the delusion.*

## CHAPTER IV

PRESENTATIONS.—Psychology must begin, then, by describing observed *appearances* (the literal translation of the word “phenomena”) without any prejudging of the issue as to what is the cause of these. So, though it may speak of such phenomena as if they were things, it must not be regarded as asserting that they are, at bottom, anything more than effects associated with brain-workings. It leaves, at the outset, that question open.

FIELD OF PRESENTATION.—All such phenomena it styles “*Presentations*,” and it regards them as located within the individual’s private “*Field of Presentation*.” (We shall employ this term in preference to the commoner “Field of Consciousness,” which is insufficiently definite.) This field of presentation contains, at any given instant of Time, all the phenomena which happen to be offered for possible observation. Let us take a concrete example of what that means. You are now reading this book, and your field of presentation contains the visual phenomena connected with the printed letters of the word you are regarding. It contains also, at the same instant, the visual phenomenon pertaining to the little numeral at the bottom of the page. This you “failed to notice”; but the numeral in question was, clearly, inside the area covered by your vision—it was affecting your brain *via* the eye, its psychical “correlate” was being offered to your attention. And that statement holds good for a host of other visual phenomena. On reflection, you will also agree that

the field must have then contained—presented to attention but left “unnoticed”—certain muscular sensations such as pressures against your body, quite a number of sounds, and the pleasant feeling produced by the air flowing into your lungs as you breathed.

ATTENTION.—It would be unsafe to say that these comparatively unnoticed phenomena were not being consciously observed. When you are watching a fall of snow, observation may be concentrated upon a single floating flake; but that does not mean that you fail to perceive the remainder. Were these to vanish, leaving the single flake in the air, their disappearance would instantly distract your startled attention from the object of your previous pre-occupation. When listening to the playing of an orchestra, you do not need to cease following the music in order to be aware that the irritating person in the seat ahead has stopped beating time with his programme. As a general rule, however, observation seems to be definitely centred upon one or another specific part of the crowd of presentations—though we have no psychical evidence to show that this is anything more than a matter of habit. Observation thus centred is called “*Attention.*” It is usual to speak of the part of the field centred upon as being in the “*Focus of Attention*”; and it is a matter of common knowledge that, at and around this “focus,” attention may be concentrated in greater or less degree of intensity.

In Physiology (the science which deals with the brain as a physical organism) the field of presentation would be merely the particular part of the cerebrum which happens to be, at that moment, in the state of activity associated with the production of psychical phenomena. And the focus of attention

would be simply that particular brain path which the maximum current of nervous energy happened to be following. One would be apt to suppose, off-hand, that this maximum flow would be produced by whatever happened to be the greatest sensory stimulation; but such could not be the rule. The hungry man, coming to the luncheon table, has his attention focussed, not upon the brightness of the shining silver, but upon the far duller sensory stimulation of the well-browned mutton chop. Attention, therefore, may be either attracted from without the organism or directed from within. If we were to attribute such directing to the ultimate observer, we should be admitting him to the status of a full-blown animus with powers of intervention. For, as every schoolboy knows, the concentrating of attention has a very marked effect in the formation of memories. But the physiologist would insist that we have no need to regard this internal directing of attention as originating in anything beyond the purely mechanical internal condition of the brain.

Now, the field of presentation at any given moment may contain a great many observable phenomena besides those sensory appearances which we have been considering. It may contain, for example, "*Memory Images.*"\*

What sort of a phenomenon is a "memory image"?

IMPRESSIONS.—Presentations may be divided into two sharply differing classes. The first of

\* I apologize to the modern psychologist for this revival of the ancient word "image." He will find, later on, that its use is perfectly justified, even though it does mean no more than the re-employment of a "disposition," or the re-stimulation of a brain path.

these comprises all phenomena which appear to the observer as directly attributable to the action of his outer sensory organs or nerve endings. That they are truly associated with the activities of such surface machinery is evident from the fact that movement of, or external interference with, the organs or nerve endings in question results in an alteration of the character of the phenomena observed, and from the equally significant fact that, in the absence of such movements or interferences, the phenomena remain unaltered and *unescapable*. They cannot, in popular parlance, be "willed away." Such phenomena are styled "*Impressions*."

IMAGES.—But now, picture to yourself a room which you remember. There is no doubt that what you are observing is a *visual* presentation—a mental *picture*. The process is not one of saying to yourself: "Let me see: there was a sofa in that corner, and a piano in the other, and the colour of the carpet was such-and-such." Rather does the whole of what you remember come before your eyes in the form of a simultaneous vision. If, however, you want to make absolutely certain that such visual pictures are not things which you deliberately manufacture from a catalogue of verbally remembered detail, you may try the following experiment. Look carefully at a painting of a landscape; then, after half an hour, try to re-visualize what you saw. You will find that you can re-observe much of the exact colouring of the original impressions,—the peculiar olives and browns and greys,—even though many of these colours were quite beyond your powers of artistic analysis, let alone verbal description. So you must be *seeing*, as an "image," an arrangement of colours similar to those which you saw as impressions.

EXTERNAL-REALITY TONE.—There is a difference between an impression and its related image which it has puzzled every psychologist to describe. It lies in the presence or absence of what is sometimes called “sensory vividness,” but what, I think, would be better referred to as “*External-reality tone.*” As compared with a room which you can see with your eyes, the room you are remembering seems unreal, yet real enough to be recognizable as a *visual*, and not, say, an *aural* image. Again, strike the rim of a wine glass, and listen to the sound as it dies away. It grows fainter and fainter till it vanishes; but to the last (as Ward points out) it retains its external-reality tone. After it has entirely disappeared, you can remember what it sounded like just before it died away. That memory is recognizable as a memory of sound—an aural image. It has all the tonal qualities of the original faint impression; but it lacks the appearance of external reality.

Again, compare the true memory image with the phenomenon commonly called an “after-impression.” The latter may be easily observed. If you stare hard for sixty seconds at a brilliant red lampshade, and then look up at the ceiling, you will see, after a moment or so, a patch of *green*, shaped in outline like the lampshade. This phenomenon is dim, exhibits little, if any, detail within its boundaries, is of the opposite (complementary) colour to the original impression, and lacks all perspective—seeming to be flat all over. It possesses, however, external-reality tone, and is clearly an impression. It moves as you move your eyes. But, while actually watching this green patch floating before you, you can observe a true memory image of the original impression of the



lampshade. It is of the original red colour, exhibits much internal detail, and appears to be three-dimensional—*i.e.*, to possess the depth apparent to binocular vision.

Five minutes later, when all trace of the green after-impression has vanished, you can observe at will clear memory images of either red lampshade or green patch.

It may be noted, then, that images are phenomena quite distinct from mere dying impressions.

## CHAPTER V

MEMORY-TRAIN.—Now, when you are trying to recall a *succession* of observed impressions, the images pertaining to these are observed as if they were actually arranged in an order corresponding to the order in which the original impressions were received. This supposed arrangement is called, as everybody knows, the "*Memory-Train*," and it is noticeable that the process of remembering events in the order in which they occurred is one which involves sometimes a very considerable mental effort. But if you are merely allowing your mind to wander—as in a daydream—without knowingly aiming at any definite goal, the set of images which is then observed appears to be arranged in a sequence which has little correspondence with any previous observed succession of events.

TRAIN OF IDEAS.—This curious succession of images is called the "*Train of Ideas*," and it is possibly a very significant fact that the simple, undirected following of a train of ideas appears to entail no mental effort or fatigue whatsoever.

Almost everybody has, at one time or another, amused himself by retracing the train of ideas which has led him, without any conscious aim on his part, to think of, or remember, a certain thing. "I saw this," he will say, "and that made me remember so-and-so; and that made me think of such-and-such." And so on. Here, however, is a specific example.

It is now evening, and in front of me stands a teacup with a chequered black and white border-

ing. The sight of this (an impression) "brings up" a memory image of the chequered oilcloth floor-covering which, this morning, I was using as material for an experiment in obtaining after-impressions. Now, at the time of making that experiment I was thinking of Ward's description of these phenomena in the "Encyclopædia Britannica"; and the next image to appear before me is an image of the red volume in question (mine is the small-print edition). Following that, there appears an image of an open page in the volume, and a very vivid image of the sensation of eye-strain involved in its reading. That "brings up" an image of the reading-glass I sometimes use. That "brings up" the image of the lens I borrowed in a fishing-tackle shop yesterday morning in order to examine some trout flies I was buying. That "brings up" the image of the friend for whom I had purchased those flies, as he stood when asking me to do so. And that "brings up" the pleasing image of the two-and-a-half pound trout I annexed from that friend's water two days ago. Thus, starting with a teacup, I arrive at a trout.

Now, examination of the nature of a train of ideas brings to light the following facts.

**GENERIC IMAGES.**—When a number of partly similar impressions have been attended to at different times, there is observable, besides the several memory images pertaining to those several impressions, a vague, general image comprising nothing beyond the key elements which are common to all those separate images. For example, the images of the hundreds of tobacco pipes which I have seen, smoked, and handled, all contain a common element which is now apparent to me as an ill-defined image of "pipe" in general. It pre-

sents all the essential characteristics which serve to distinguish a pipe from any other article such as, say, an umbrella. Such characteristics are: Hollow bowl, tubular stem—in short, an appearance of utility for the purpose of smoking. But this indefinite image does not exhibit any indication of specific colour or precise dimensions. It seems, however, to be the nucleus of all the definite images of *particular* pipes to be found in my mental equipment; for, if attention be directed to it, there will quickly become observable the image of sometimes one and sometimes another of such particular pipes.

These vague, almost formless general images are called "*Generic Images*," and they appear to be analogous to a central knot to which the specific, definite images are in the relation of radiating threads.

ASSOCIATIONAL NETWORK.—It is obvious that many of these threads—these definite images—may be radiating also from another generic image. A definite image of a particular wooden pipe-bowl may pertain, on one side, to the generic image "pipe," and, on another, to the generic image I call "grained wood." That generic image may have, as another of its components, a definite image of a polished walnut table, which image, again, may also be a radiating thread pertaining to the generic image "furniture." A thread from "furniture"—say, the image of a particular suite seen in a shop window—may be the link with the generic image "antiquities." So far, then, we are confronted with something analogous to a network of knots (generic images) and radiating threads (definite images) along the meshes of which attention may be led without conscious effort on the part of the observer. Ideas linked together in this manner

graphically analogous to a network of knots and threads are said to be "associated." Hence we may refer to the structure in question as the "*Associational Network*."

It is commonly assumed that association is of two kinds: association by *similarity*, as when one event recalls a similar event which may have happened long ago; and association by *contiguity*, which means that, when two events have occurred in close succession, the recalling of one leads to the recollection of the other.

To the physiologist the associational network is simply the network of brain-paths, the "knots" being regions—or patterns—therein, and the "connecting threads" being paths which pertain to more than one such region—or pattern. All the phenomena of association seem to be adequately accounted for on that supposition; and on no other theory, so far as I can see, is it possible to account for association by "*similarity*" at all.

In the absence of any other guidance, the path taken by the train of ideas seems to be conditioned very largely by the factor of *freshness* in the images. Other things being equal, an image which has been recently established makes a stronger bid for the wandering attention than does one which has long been neglected. The reader will notice that, in the example of a train of ideas given a little way back (the one which began with a teacup), all the images related to experiences which had recently occurred. For example, the black and white chequering of the teacup led me, not to chess, which is a very obtrusive generic image of mine, but to the piece of linoleum I had seen that morning. Physiologically, this would mean that brain-paths which have been recently traversed offer a

better passage to the currents of nervous energy than do those which have been allowed to fall into disuse.

The supposed "memory-train" does not appear to be anything more than a particular pathway through the associational network, the pathway which happens to have been thus recently traversed. If you try to trace a "memory-train" back for more than a little way, you find that the path has ceased to be clearly marked out: the images do not come up in a steadily correct sequence of, so to say, their own accord. You have to help the memory out by *reasoning* as to which event must have happened next—and sometimes you reason wrongly.

DREAMS.—Dreams, like many other mental phenomena, are composed largely of images supplied by an associational network. But they differ from mind-wandering in several important respects. In the latter form of activity reason is nearly always partially at work to determine the course to be followed along the network. But in dreams this guidance seems to be largely lacking, and the dream images present themselves as real—though curiously unstable—episodes in a personal adventure story of an only partially reasonable character.

INTEGRATION.—Association between the dream images is sometimes clear enough; but, as a general rule, such association takes the curious form known as an "*Integration*." By this word we shall mean: "A combination of associated images in which the composing elements are qualitatively distinguishable." (This definition is from Baldwin's "Dictionary of Philosophy and Psychology".) For example, the image of a pink dress seen in a shop window on Monday, and that of a shop girl seen when the same place is re-visited on Tuesday, may

combine, in Tuesday night's dream, into a single image of the shop girl wearing the pink dress. But on waking and recalling the dream, the two components of the dream-image, dress and girl, are clearly distinguishable as images of originally separate impressions.

\* \* \* \* \*

CONCEPTS.—It will be noticed that, in the foregoing list of definitions, no attempt has been made to delve below that class of thought process which is styled "imagery"—a class in regard to which the psychoneural connection suggests itself very readily. Thought processes of a higher order are not yet properly—or even, perhaps, improperly—understood. Our knowledge of these is of the very vaguest description. There appear to be certain generalized ideas called "*Concepts*," such as, for example, those we employ when we think of "eating," "playing," "imagining," or of "difficulty," "truth," "deception," "difference"; but it is even doubtful whether these may legitimately be herded together under any such single class-name. Compare, for instance, "eating" with "difference." The former idea *may* be no more than the stimulation of the more broadly determinative lines of some extensive pattern in the *plexus* of brain-paths; but the latter may claim a connection with, or share in, every single idea we can formulate.

It is here that the animist is enabled to put up his best fight in defence of the observer's alleged power of intervention. But even here the materialist may claim to have overrun a considerable part of the disputed territory. For the man whose brain has been injured by disease may, apparently, forget what "eating" is; or may be more than a little hazy

regarding the existence of a "difference" betwixt himself and a grasshopper.

Our present pathway does not take us across this particular battlefield; though we pass within hailing distance of the combatants. From them, however, we may accept the information that concepts are often determinants of the route that attention follows through the associational net. It is hardly possible for the unguided attention to dwell upon any concept without finding itself, a moment later, confronted by a generic, or even specific, image clearly related to that main idea.

\*            \*            \*            \*            \*

Before we pass on to the next section, there is one aspect of psychology which had best be made perfectly clear. In all sciences, new facts may be discovered by:

(1) Logical deduction from already established facts;

(2) Direct experiment;

(3) Both processes corroborating each other.

A fact which is in class 2 alone (*i.e.*, one which has not been logically deduced from other facts) requires considerably more in the way of experimental proof than does a fact in class 1. If, indeed, it is of the kind which could not conceivably be deducible from any other knowledge at our disposal (*e.g.*, that we experience "pain" when a certain kind of nerve is over-stimulated), it cannot be regarded as scientifically useful unless it fulfils the condition that it is "*open to anybody to observe*" (Baldwin's "Dictionary of Philosophy and Psychology"). A great many psychological facts are of this non-deducible kind; and, in dealing with these, the psychologist follows the scientific rule.



He is not content to say: "Men of unimpeachable integrity and unquestionable authority have investigated such-and-such mental phenomena, and the outcome of their inquiries has been to establish, etc., etc." On the contrary, his assertions (as distinct from his speculations) will always be found to imply: "Do this or that with *your* mind, and *you* will observe that the facts are of such-and-such a character."

The particular matter with which we shall be concerned in this book was, when first discovered, an apparently non-deducible fact in class 2 alone, and it had to be treated accordingly. Later on it was found to be a fact in class 1 (*i.e.*, directly deducible from facts already established). Thus, in the end, it is presented to the reader as a fact in class 3.

## PART II

### CHAPTER VI

IN this section, it will be necessary to relate, as briefly as possible, the regrettably dramatic and extremely misleading incidents referred to in the second paragraph of the first chapter (the reader will remember the assurance given therein). It will be noticed that the incidents in question mimicked to perfection many classical examples of alleged "clairvoyance," "astral-wandering," and "messages from the dead or dying." It will be understood that they are described merely for their illustrative worth (the reader who has followed what has been written on the subject of psychological evidence will appreciate this), and because they form part of the "narrative of the actual proceedings involved." But, from one point of view, these occurrences had a value entirely unique. This was because I was not, as is usually the case in such matters, compelled to take them at second-hand from some "clairvoyant" or "medium"—with all the important points left out and a mass of misleading suggestion thrown in. For they happened, one and all, to myself.

\* \* \* \* \*

The first incident provided a very fair example of what might easily have passed for "clairvoyance."

It occurred in 1898, when I was staying at an hotel in Sussex. I dreamed, one night, that I was having an argument with one of the waiters as to what was the correct time. I asserted that it was half-past four in the afternoon: he maintained that

it was half-past four in the middle of the night. With the apparent illogicality peculiar to all dreams, I concluded that my watch must have stopped; and, on extracting that instrument from my waistcoat pocket, I saw, looking down on it, that this was precisely the case. It had stopped—with the hands at half-past four. With that I awoke.

The dream had been a peculiar one (in ways which have nothing to do with this book), and the net result of it all was that I lit a match to see whether the watch had really stopped. To my surprise it was not, as it usually is, by my bedside. I got out of bed, hunted round, and found it lying on the chest of drawers. Sure enough, it *had* stopped, and the hands stood at half-past four.

The solution seemed perfectly obvious. The watch must have stopped during the previous afternoon. I must have noticed this, forgotten it, and remembered it in my dream. Satisfied on that point, I rewound the instrument, but, not knowing the real time, I left the hands as they were.

On coming downstairs next morning, I made straight for the nearest clock, with the object of setting the watch right. For if, as I supposed, it had stopped during the previous afternoon, and had merely been rewound at some unknown hour of the night, it was likely to be out by several hours.

To my absolute amazement I found that the hands had only lost some two or three minutes—*about the amount of time which had elapsed between my waking from the dream and rewinding the watch.*

This meant, of course, that the watch had stopped at the actual moment of the dream. The latter was probably brought about by my missing the accustomed ticking. But—how did I come to see, in that dream, that the hands stood, as they actually did, at half-past four?

If anyone else had told me such a tale I should probably have replied that he had dreamed the whole episode, from beginning to end, including the getting up and re-winding. But that was an answer I could not give to myself. I *knew* that I had been awake when I had risen and looked at the watch lying on the chest of drawers. Yet, what was the alternative? "Clairvoyance"—seeing across space through darkness and closed eyelids? Even supposing that there existed unknown rays which could effect that sort of penetration, and then produce vision,—which I did not believe,—the watch had been lying at a level above that of my eyes. What sort of rays could these be which bent round corners?

From Sussex, I went to Sorrento, in Italy. Lying in bed there one morning, I awoke and fell to wondering what the time might be. I lacked energy to look at my watch, which lay outside the mosquito curtains, on a small table within reach, but out of sight when my head was on the pillow. It occurred to me to experiment with the object of ascertaining whether I could again see that watch in the apparently "clairvoyant" fashion of the earlier experience. Closing my eyes, and concentrating my thoughts upon wondering what the time might be, I fell into one of those semi-dozes in which one is still aware of one's situation. A moment later I found myself looking at the watch. The vision I saw was binocular, upright, poised in space about a foot from my nose, illumined by ordinary daylight, and encircled by a thick, whitish mist which filled the remainder of the field of sight. The hour hand stood at exactly eight o'clock; the minute hand was wavering between the twelve and the one: the second hand was a formless blur. To look more intently would, I felt, wake me completely, so I made up

my mind to treat the minute hand as one treats the needle of a prismatic compass, and to divide the arc of its swing. This gave the time as two and a half minutes past eight. That decided, I opened my eyes, reached out under the mosquito curtains, grabbed the watch, pulled it in, and held it up before me. I was wide awake, and—the hands stood at two and a half minutes past eight.

This time there seemed to be no way out. I was driven to the conclusion that I possessed some funny faculty of *seeing*—seeing through obstacles, across space, and round corners.

But I was wrong.

\* \* \* \* \*

Then came an incident of an entirely different character.

In January, 1901, I was at Alassio, on the Italian Riviera, having been invalided home from the Boer War. I dreamed, one night, that I was at a place which I took to be Fashoda, a little way up the Nile from Khartoum. The dream was a perfectly ordinary one, and by no means vivid, except in one particular. This was the sudden appearance of three men coming from the South. They were marvellously ragged, dressed in khaki faded to the colour of sackcloth; and their faces under their dusty sun-helmets were burned almost black. They looked, in fact, exactly like soldiers of the column with which I had lately been *trekking* in South Africa, and such I took them to be. I was puzzled as to why they should have travelled all the way from that country to the Soudan, and I questioned them on that point. They assured me, however, that this was precisely what they had done. "We have come right through from the Cape," said one. Another added: "I've had an awful time. I nearly died of yellow fever."

The remainder of the dream was unimportant.

At that time we were receiving the *Daily Telegraph* regularly from England. On opening this paper at breakfast, the morning after the dream, my eye was caught by the following flaring headlines :

## THE CAPE TO CAIRO "DAILY TELEGRAPH"

### EXPEDITION AT KHARTOUM

*From our special correspondent.*

KHARTOUM, Thursday (5 p.m.).

The "Daily Telegraph" expedition has arrived at Khartoum after a magnificent journey, etc., etc.

A note in another part of the paper stated that the expedition was led by M. Lionel Declé. I heard or read subsequently that one of the three white men of the party had died *en route*; not, however, of yellow fever, but of enteric. Whether this was true, or whether there were three white leaders, I do not know.

One or two remarks may be made here.

I had heard, some years previously, that M. Lionel Declé was contemplating some such trans-continental journey; but I did not know that anything had come of the scheme. Certainly I had no idea that the expedition had started.

The expedition arrived at Khartoum the day before the news was published in London, and thus long before I had the dream, as that issue of the paper had to get from London to Alassio, and the dream did not occur till the night before its arrival.

This put any "astral-wandering" business completely out of the question.

I attempted no explanation.

\* \* \* \* \*

The next incident was as dramatic as any lover of the marvellous could desire.

In the spring of 1902 I was encamped with the 6th Mounted Infantry near the ruins of Lindley, in the (then) Orange Free State. We had just come off *trek*, and mails and newspapers arrived but rarely.

There, one night, I had an unusually vivid and rather unpleasant dream.

I seemed to be standing on high ground—the upper slopes of some spur of a hill or mountain. The ground was of a curious white formation. Here and there in this were little fissures, and from these jets of vapour were spouting upward. In my dream I recognized the place as an island of which I had dreamed before—an island which was in imminent peril from a volcano. And, when I saw the vapour spouting from the ground, I gasped: "It's the island! Good Lord, the whole thing is going to *blow up!*" For I had memories of reading about Krakatoa, where the sea, making its way into the heart of a volcano through a submarine crevice, flushed into steam, and blew the whole mountain to pieces. Forthwith I was seized with a frantic desire to save the four thousand (I knew the number) unsuspecting inhabitants. Obviously there was only one way of doing this, and that was to take them off in ships. There followed a most distressing nightmare, in which I was at a neighbouring island, trying to get the incredulous *French* authorities to despatch vessels of every and any description to remove the inhabitants of the threatened island. I was sent from one official to another;

and finally woke myself by my own dream exertions, clinging to the heads of a team of horses drawing the carriage of one "Monsieur le Maire," who was going out to dine, and wanted me to return when his office would be open next day. All through the dream the *number* of the people in danger obsessed my mind. I repeated it to everyone I met, and, at the moment of waking, I was shouting to the "Maire," "Listen! Four thousand people will be killed unless——"

I am not certain now when we received our next batch of papers, but, when they did come, the *Daily Telegraph* was amongst them, and, on opening the centre sheet, this is what met my eyes:

**VOLCANO DISASTER**  
IN  
**MARTINIQUE**  
—  
**TOWN SWEEPED AWAY**  
—  
**AN AVALANCHE OF FLAME**  
—  
**PROBABLE LOSS OF OVER**  
**40,000 LIVES**  
—  
**BRITISH STEAMER BURNT**

One of the most terrible disasters in the annals of the world has befallen the once prosperous town of St. Pierre, the commercial capital of the French island of Martinique in the West Indies. At eight o'clock on Thursday morning the volcano Mont Pelée which had been quiescent for a century, etc., etc.—



But there is no need to go over the story of the worst eruption in modern history.

In another column of the same paper was the following, the headlines being somewhat smaller :

### **A MOUNTAIN EXPLODES**

There followed the report of the schooner *Ocean Traveller*, which had been obliged to leave St. Vincent owing to a fall of sand from the volcano there, and had subsequently been unable to reach St. Lucia owing to adverse currents opposite the ill-fated St. Pierre. The paragraph contained these words :

When she was about a mile off, the volcano Mont Pelée exploded.

The narrator subsequently described how the mountain seemed to split open all down the side.

Needless to say, ships were busy for some time after, removing survivors to neighbouring islands.

There is one remark to be made here.

The number of people declared to be killed was not, as I had maintained throughout the dream, 4,000, but 40,000. I was out by a nought. But, when I read the paper, I read, in my haste, that number as 4,000; and, in telling the story subsequently, I always spoke of that printed figure as having been 4,000; and I did not know it was really 40,000 until I copied out the paragraph fifteen years later.

Now, when the next batch of papers arrived, these gave more exact estimates of what the actual loss of life had been; and I discovered that the true figure had nothing in common with the arrangement

of fours and noughts I had both dreamed of, and gathered from the first report. So my wonderful "clairvoyant" vision had been wrong in its most insistent particular! But it was clear that its wrongness was likely to prove a matter just as important as its rightness. For *whence*, in the dream, had I got that idea of 4,000? Clearly it must have come into my mind *because of the newspaper paragraph*. This suggested the extremely unpleasant notion that the whole thing was what doctors call "Identifying Paramnesia"; that I had never really had any such dream at all; but that, on reading the newspaper report, a false idea had sprung up in my mind to the effect that I had previously dreamed a dream containing all the details given in that paragraph.

Moreover, reflection showed that the Cape to Cairo vision might very well have been of the same character.

Indeed, the more I thought of the two episodes the clearer it became that, in each case, the dream had been precisely the sort of thing I might have expected to have experienced *after* reading the printed report—a perfectly ordinary dream based upon the personal experience of reading. How, then, could I be sure that those dreams had not been *false memories* engendered by the act of reading?

But there was the watch business to be taken into account. That, certainly, could not be made to fit in with the new theory; unless I were a great deal madder than I could bring myself to believe.

I was, however, absolutely satisfied that neither in the Cape to Cairo nor in the Mont Pelée dream had there been any "astral wandering," or any direct vision across leagues of space, or any "mes-

sages" from the actors in the actual episodes represented. These dreams had been induced, either by the readings of the paragraphs, or else by telepathic communications from the journalist in the *Daily Telegraph* office who had written those accounts.

## CHAPTER VII

To my great relief, the next experience, which occurred some two years later, completely squashed the "Identifying Paramnesia" theory.

I dreamed that I was standing on a footway of some kind, consisting of transverse planks flanked on my left side by some sort of railing, beyond which was a deep gulf filled with thick fog. Overhead, I had an impression of an awning. But this last was not clearly seen, for the fog partly hid everything except three or four yards of the planking ahead of me with its attendant portion of railing and gulf. Suddenly I noticed, projecting upwards from somewhere far down in the gulf, an immensely long, thin, shadowy thing like a gigantic lath. It reached above the plankway, and was slanted so that it would, had the upper end been visible through the fog, have impinged upon the awning. As I stared at it, it began to wave slowly up and down, brushing the railing. A moment later I realized what the object was. I had seen just such a thing once before in a cinema picture of a fire in the early days of cinematography. Then, as now, I had undergone the same puzzlement as to what this sort of waving lath might be, until I had realized that it was the long water-jet from a fire-engine hose, as photographed through intervening smoke. Somewhere down in that gulf, then, there must be a fire-engine, and it was playing a stream of water upon the smoke-hidden, railed structure where I stood. As I perceived this, the dream became perfectly abominable. The wooden plank-

way became crowded with people, dimly visible through the smoke. They were dropping in heaps; and all the air was filled with horrible, choking, gasping ejaculations. Then the smoke, which had grown black and thick, rolled heavily over everything, hiding the entire scene. But a dreadful, suffocated moaning continued—and I was entirely thankful when I awoke.

I was taking no chances with "Identifying Paramnesia" this time. I carefully recalled every detail of the dream after waking, and not till I had done this did I open the morning papers. There was nothing in these. But the evening editions brought the expected news.

There had been a big fire in a factory somewhere near Paris. I think it was a rubber factory, though I cannot be sure. At any rate it was a factory for some material which gave off vile fumes when burning. A large number of workgirls had been cut off by the flames, and had made their way out on to a *balcony*. There, for the moment, they had been comparatively safe, but the ladders available had been too short to admit of any rescue. While longer ones were being obtained, the fire-engines had directed streams of water on to the balcony to keep that refuge from catching alight. And then there happened a thing which must, I imagine, have been unique in the history of fires. From the broken windows behind the balcony the smoke from the burning rubber or other material came rolling out in such dense volumes that, although the unfortunate girls were standing actually in the open air, everyone of them was suffocated before the new ladders could arrive.

This dream left the whole business more puzzling than ever. It seemed that nothing could explain

it. For "clairvoyance" is not an explanation. It is a meaningless expression, a mere admission of inexplicability. And "telepathy" required an enormous amount of stretching before it could be made to fit the facts.

\* \* \* \* \*

Then came a dream which somewhat simplified matters. For it ruled out definitely: Insanity, clairvoyance, astral-wandering, spirit-messages, and telepathy. But it left me face to face with something much more staggering than any of these.

In 1904, a few months after the fire dream, I was staying at the Hotel Scholastika, on the borders of the Aachensee, in Austria. I dreamed one night that I was walking down a sort of pathway between two fields, separated from these last by high iron railings, eight or nine feet high, on each side of the path. My attention was suddenly attracted to a horse in the field on my *left*. It had apparently gone mad, and was tearing about, kicking and plunging in a most frenzied fashion. I cast a hasty glance backwards and forwards along the railings to see if there were any opening by which the animal could get out. Satisfied that there was none, I continued on my way. A few moments later I heard hoofs thundering behind me. Glancing back I saw, to my dismay, that the brute *had* somehow got out after all, and was coming full tilt after me down the pathway. It was a full-fledged nightmare; and I ran like a hare. Ahead of me the path ended at the foot of a flight of wooden steps rising upward. I was striving frantically to reach these when I awoke.

Next day I went fishing with my brother down

the little river which runs out of the Aachensee. It was wet-fly work, and I was industriously flogging the water when my brother called out: "Look at that horse!" Glancing across the river, I saw the scene of my dream. *But, though right in essentials, it was absolutely unlike in minor details.* The two fields with the fenced-off pathway running between them were there. The horse was there, behaving just as it had done in the dream. The wooden steps at the end of the pathway were there (they led up to a bridge crossing the river). But the fences were wooden and small,—not more than four or five feet high,—and the fields were ordinary small fields, whereas those in the dream had been park-like expanses. Moreover, the horse was a small beast, and not the rampaging great monster of the dream—though its behaviour was equally alarming. Finally, it was in the wrong field, the field which would have been on my *right*, had I been walking, as in the dream, down the path towards the bridge. I began to tell my brother about the dream, but broke off because the beast was behaving so very oddly that I wanted to make sure that it could not escape. As in the dream, I ran my eye critically along the railings. As in the dream, I could see no gap, or even gate, in them anywhere. Satisfied, I said, "At any rate, *this* horse cannot get out," and re-commenced fishing. But my brother interrupted me by calling, "Look out!" Glancing up again, I saw that there was no dodging fate. The beast *had*, inexplicably, just as in the dream, got out (probably it had jumped the fence), and, just as in the dream, it was thundering down the path towards the wooden steps. It swerved past these and plunged into the river, coming straight towards us. We both picked up stones, ran thirty

yards or so back from the bank, and faced about. The end was tame, for, on emerging from the water on our side, the animal merely looked at us, snorted, and galloped off down a road.

Now, it seemed to me that from this incident one thing was abundantly clear. These dreams were not *precepts* (impressions) of distant or future events. They were the usual commonplace dreams composed of distorted *images* of waking experience, built together in the usual half-senseless fashion peculiar to dreams. That is to say, *if they had happened on the nights after the corresponding events*, they would have exhibited nothing in the smallest degree unusual, and would have yielded just as much true, and just as much false, information regarding the waking experiences which had given rise to them as does any ordinary dream—which is very little.

They were the ordinary, appropriate, expectable dreams; but they were occurring on the *wrong nights*.

Even the watch dreams were merely the dreams I ought to have had *after* seeing the watch. In the first of those incidents I had, when awake, seen the watch lying *face upwards* on the chest of drawers, with the hands stopped; and the corresponding dream image had been of a stopped watch, face upwards. In the second instance I had *held the watch up facing me about a foot from my nose, while lying with my head on my pillow*; and the reader will remember that the corresponding dozing image had been of a watch in precisely that position. The white mist had been, of course, the image of the mosquito curtains out of focus, as these were when I looked at the real watch.

No, there was nothing unusual in any of these



dreams as dreams. They were merely *displaced in Time*.

That, of course, was staggering enough. But I felt, nevertheless, that it had been a great advance to resolve all these varied phenomena into one single class of incident—a simple, if mysterious, transposition of dates.

But in all this speculation I was still a long way from the truth.

The two remaining incidents I propose to relate in this section contained nothing to alter my half-formed opinion that temporal aberration constituted the whole of the mystery involved. But, had I not made this semi-discovery, I should certainly have regarded the following incident as a message from the "spirit-world" or a "phantasm of the dying."

\* \* \* \* \*

In 1912 I spent a good deal of time at Salisbury Plain, experimenting with one of my stable aeroplanes. A military aeroplane competition was in progress, and most of the officers of the then tiny Royal Flying Corps were there. One of these I had not met before, nor did I see very much of him; in fact, I do not think I spoke to him more than twice. Since these records are not evidence, or intended to be regarded as such, it will suffice if I refer to him as Lieutenant B. The other officers were all old friends of mine. Shortly after the conclusion of the competition the annual army manœuvres began, and, having nothing to do with these, I went to Paris to inspect another machine which was being built there to my design.

One morning while in that city I dreamed that I was standing in a very large meadow, situated in a landscape which I did not recognize. In this

meadow a monoplane landed, crashing rather badly some fifty yards away. Immediately afterwards I saw B. coming to me from the direction of the wreck. I asked if much damage had been done. He replied, "Oh no, not much," and then added, "It's all that beastly engine; but I've got the hang of it now." The dream was a longish one, all about aeroplane accidents (a common form of nightmare with me, even to this day), and B.'s smash was by no means the worst thing I saw. I awoke to find the servant by my bedside with the morning tea, from which fact I was subsequently able to fix the hour of the dream as close on 8 a.m.

B. was killed between 7 and 8 that morning, falling into a meadow near Oxford. But I did not read of the accident till about two days and a night later.

But now, note the following points :

1. Engine failure had nothing whatever to do with the accident, nor could B. for one moment have ever thought that it had. For the monoplane was planing down—with the engine partly or entirely stopped—at the time; and the accident was due to the uncoupling of a quick-release gadget in one of the main "lift" wires, and the consequent breaking upward of one wing. Of course, the planing down may have been compulsory, and due to engine failure; but there could have been no doubt in B.'s mind that his wing had broken.

On the other hand, B. had made to my sister, while we were at the Plain, a remark about the engine almost exactly like that I heard him make in the dream, and it is more than likely that she had repeated it to me. She would naturally have done so.

2. B. was merely a passenger in the machine. It

was being piloted by another man, a stranger to me, who was also killed. There was nothing of this in the dream.

But when I read the paragraph about the catastrophe, it was B.'s name alone which caught and held my attention; and I did not know of the death of the other man until I looked up the record of the accident several years later.

3. The paragraph did not state the cause of the accident, and so left me with nothing to go upon but (possibly) B.'s past remark about the engine.

4. The coincidence in time was not really remarkable. Dreams of aeroplane accidents were, as I have said, very frequent with me in those days, and between seven and eight, when the noise of motor traffic in the streets begins to penetrate to one's consciousness, has always been my hour for this particular class of nightmare.

So I concluded that here, again, the dream was associated with the personal experience of reading the paragraph.

\* \* \* \* \*

In the last incident of this series, the chronological aberration was far more considerable.

The dream occurred in the autumn of 1913. The scene I saw was a high railway embankment. I knew in that dream—knew without questioning, as anyone acquainted with the locality would have known—that the place was *just north of the Firth of Forth Bridge*, in Scotland. The terrain below the embankment was open grassland, with people walking in small groups thereon. The scene came and went several times, but the last time I saw that a train going north had just fallen over the embankment. I saw several carriages lying towards the

bottom of the slope, and I saw large blocks of stone rolling and sliding down. Realizing that this was probably one of those odd dreams of mine, I tried to ascertain if I could "get" the date of the real occurrence. All I could gather was that this date was somewhere in the following spring. My own recollection is that I pitched finally upon the middle of April, but my sister thinks I mentioned March when I told her the dream next morning. We agreed, jokingly, that we must warn our friends against travelling north in Scotland at any time in the succeeding spring.

On April the 14th of that spring the "Flying Scotsman," one of the most famous mail trains of the period, jumped the parapet near Burntisland Station, about fifteen miles north of the Forth Bridge, and fell on to the golf links twenty feet below.

\* \* \* \* \*

The above-described incidents have been selected from a group of about twenty, simply because they were closely studied and carefully memorized at the time of their occurrence. Most of the others were merely noted, so to say, *en passant*, and are now almost completely forgotten. Curiously, I can remember no dreams of the coming Great War—except one. That one related to the bombardment of Lowestoft by the German fleet. I recognized the place as Lowestoft, but had no idea as to the nationality of the bombarding vessels.

## PART III

### CHAPTER VIII

No one, I imagine, can derive any considerable pleasure from the supposition that he is a freak; and, personally, I would almost sooner have discovered myself to be a "medium." There might have been a chance of company there. Unfortunately it was abundantly clear that there was no "mediumship" in this matter, no "sensitiveness," no "clairvoyance." I was suffering, seemingly, from some extraordinary fault in my relation to reality, something so uniquely wrong that it compelled me to perceive, at rare intervals, large blocks of otherwise perfectly normal personal experience displaced from their proper positions in Time. That such things could occur at all was a most interesting piece of knowledge. But, unfortunately, in the circumstances it could be knowledge to only one person—myself.

There was, however, a very remote possibility that, by employing this piece of curiously acquired knowledge as a guide, I might be able to discover some hitherto overlooked peculiarity in the structure of Time; and to that task I applied myself.

Progress here was definite, but it was terribly slow. There was no help to be found in the conception of Time as a fourth dimension. For Time has always been treated by men of science as if it were a fourth dimension. What had to be shown was the possibility of displacement in that dimension. Nor did I gather much comfort from Berg-

son; for to tell a man who is confronted with parts of Time clearly transposed that Time has no parts is distinctly futile. I cared not a whit whether Time were "a form of thought," or an aspect of reality, or (this was later) compoundable with Space. What I wanted to know was: How it got *mixed?*

For "mixed" was the right word. Between the dream and the corresponding waking experience came the memory of the dream, while the memory of the waking experience followed them all!

However, the coming of the first world war put a temporary stop to further investigation; and it was not until 1917 that any new developments occurred.

In January of that year I was in Guy's Hospital, recovering from an operation. There, one morning, when reading a book, I came upon a reference to one of those "combination" locks which are released by the twisting of rings embossed with letters of the alphabet. As I read this, something seemed, for one fleeting instant, to be stirring, so to say, in my memory; but whatever it was it immediately subsided. I paused for a second, but nothing further developed, so I returned to my book. Then, luckily, I changed my mind, tossed the volume aside, and set myself determinedly to worry out exactly what it was that I had momentarily associated with the sentence read. In a little while it came back. I had dreamed, during the previous night, of precisely such a combination lock.

The chances of coincidence, where two such vague, commonplace events were concerned, needed no pointing out. But I could not remember having seen, heard, or thought of such a lock for a year

or more. And, knowing from past happenings that my dreams did, sometimes, contain images of future experience, it seemed to me that the appearance of the lock image in the previous night's dream might have been another instance of my particular abnormality. Such a supposition might prove, at any rate, worth considering.

A few days later the great Silvertown explosion occurred, shaking the whole building, breaking windows, and causing the nurses to extinguish the lights, on the supposition that Zeppelins were overhead. Such an experience was calculated to make one dream; and dream I did, but, as usual, on the wrong night—the night before the associated event. After the disaster I told a fellow-convalescent of this experience. He interrupted me, saying, "Wait!" and then: "Curious, that. Now that I come to think of it, I also dreamed of an explosion last night."

He could no longer, by then, recall any of the details of his dream, and, since big bangs of all sorts were fairly common during the war, coincidence might well have been responsible for the facts. But—supposing this were not the case, and that the dream had been in the same class as mine? What followed?

There were thus two new suppositions to be examined. Viewed separately, each of these appeared wild in the extreme; but considered together they were sufficiently suggestive to justify a little closer attention.

The validity of the first of these would mean that my dream pre-images were connected, not only with highly exciting and dramatic events, but also with the veriest trivialities, such as this little matter of reading about a combination lock. Exactly, in

fact, as dream images of past events are connected just as often with unimportant happenings as with experiences more striking. Again, it had been by the merest accident of fortune that I had set myself to recall that dream; and had I not done so I should never have been aware of the incident. According to this, then, I might, for all I could tell, have had these dreams with considerable frequency, and have either forgotten them at once, or else have *failed to notice their connection* with the subsequent related events.

But if the supposition about my friend's dream were correct, *this failure to observe a connection was precisely what had happened in his case*. He had not completely forgotten the dream, but the occurrence of the actual explosion had not served to recall it.

I had got no further than this in my speculations when the friend in question came up in a state of some excitement. "You remember what we were saying about dreams?" he asked. "Well, I have been talking to So-and-So" (one of the hospital surgeons), "and he told me of a curious thing which had happened to him the other night. He had just got into bed and gone to sleep when he dreamed that he was aroused and compelled to go out to attend to a fractured leg. Almost immediately after his dream he *was* aroused, owing to the arrival of an urgent message which necessitated his going out to attend to just such a case. And in telling me the story he pointed out that he had not had to deal with a fractured leg for over six weeks."

So here, possibly, was a third incident, involving a third person. What, I wondered, would become of the record of that event? The surgeon would



tell it to a few friends, who would attribute the whole thing to coincidence (it *might* have been that), and in course of time he would forget all about it himself. But——

And then, what about that curious feeling which almost everyone has now and then experienced—that sudden, fleeting, disturbing conviction that something which is happening at that moment *has happened before?*

What about those occasions when, receiving an unexpected letter from a friend who writes rarely, one recollects having dreamed of him during the previous night?

What about all those dreams which, after having been completely forgotten, are suddenly, for no apparent reason, recalled later in the day? *What is the association which recalls them?*

What about those puzzling dreams from which one is awakened by a noise or other sensory event—dreams in which the noise in question appears as the final dream incident? Why is it that this closing incident *is always logically led up to by the earlier part of the dream?*

What, finally, of all those cases, collected and tabulated by the Society for Psychical Research, where a dream of a friend's death has been followed by the receipt, next day, of the confirmatory news? Those dreams were, clearly, not "spirit messages," but instances of *my* "effect"—simple dreams associated merely with the coming personal experience of *reading the news.*

I had done nothing but suppose, in hopelessly unscientific fashion, for a week or more, and it seemed to me that I might as well complete my sinning. So I took a final wild leap to the wildest supposition of all.

Was it possible that these phenomena were not abnormal, but *normal*?

That dreams—dreams in general, all dreams, everybody's dreams—were composed of *images of past experience and images of future experience blended together in approximately equal proportions?*

That the universe was, after all, really stretched out in Time, and that the lop-sided view we had of it—a view with the "future" part unaccountably missing, cut off from the growing "past" part by a travelling "present moment"—was due to a purely mentally imposed barrier which existed only when we were awake? So that, in reality, the associational network stretched, not merely this way and that way in Space, but also backwards and forwards in Time; and the dreamer's attention, following in natural, unhindered fashion the easiest pathway among the ramifications, would be continually crossing and recrossing that properly non-existent equator which we, waking, ruled quite arbitrarily athwart the whole.

The foregoing supposition was not, be it noted, perceived as a possible *explanation*. The mixture in the order of actual experience—viz., dream, memory of dream, corresponding waking impression, and memory thereof—would still have to be accounted for. But it would put the problem on an entirely different footing. There would be no longer any question as to why a man should be able to observe his own future mental states; that would be normal and habitual. On the contrary, the initial puzzle would be: What was the *barrier* which, in certain circumstances, debarred him from that proper and comprehensive view?

All this was seen in, so to say, a single flash of thought, almost too rapid for analysis.

It was rejected with even greater swiftness. For it was absolutely inconceivable that a thing of this sort, if true, could have managed to escape, through all these centuries, universal perception and recognition.

## CHAPTER IX

A LITTLE later on, however, I saw that this abrupt recoil had been illogical. For the whole supposition had been based, of course, upon the earlier hypothesis that any general recollection of these images was rendered difficult by the species of inhibition which had prevented my friend from associating his waking experience of the explosion with his previous dream. No memory is ever aroused unless there is some associated idea which revives it, and if that association misses fire, there can be no recall.

Dreams, moreover, are mostly about trivial things—things which happen every day of one's life. Such a dream, even if it were, in actual fact, related to to-morrow's event, would naturally be attributed to yesterday's similar incident. Then, again, nine-tenths of all dreams are completely forgotten within five seconds of waking, and the few which survive rarely outlast the operation of shaving. Even a dream which has been recalled and mentally noted is generally forgotten by the afternoon. Add to this the before-mentioned partial mental ban upon the requisite association; add to that an unconscious, matter-of-fact assumption of impossibility; and it becomes quite probable that it would be only a very few of the more striking, more detailed, and (possibly) more emotional incidents which would ever be noticed at all. These, moreover, would be attributed to telepathy or to "spirit messages," or even to anything which, though insane in other respects, could, at least, be expressed in

the conventional terms of a single, absolute, one-dimensional Time.

It was true, of course, that the theory of normality would take a lot of threshing out. The statement made in the last chapter was, obviously, incomplete; and the full description of the process involved might never be forthcoming. But the alternative was the hypothesis of abnormality; and that meant, not merely abnormality in the sense of excess of, or deficiency in, some common quality of mind, but abnormality in a sense which was itself senseless. It is difficult to really believe in the utterly meaningless.

Finally (and this was what attracted me most), the supposition of normality—of something inherent, not in this or that individual, but in Time itself—would mean, if correct, that the phenomena in question ought to be potentially “open to anyone to observe, provided he fulfilled the necessary conditions.”

Hence, if one could devise an experiment which would overcome the two initial difficulties of remembering and associating, the thing should prove to be *directly observable by every normal individual*, including the present reader.

The arrangement of that experiment was, clearly, the first step. Explanation could come (and, as will be seen, did come) later.

## CHAPTER X

THE reader will have guessed that the experiment referred to in the last chapter was tried, and that it proved successful; because otherwise, manifestly, this book would never have been written.

It was not, however, until the following winter that I could bring myself to take the normality hypothesis seriously enough to put it to the test. Then, with many misgivings, and practically no hope of success, I began the first essential experiment, upon myself. I knew, of course, that I had these dreams occasionally; but only at intervals of sometimes a year or more. According to the new theory, however, I should be having similar dreams throughout all these intervals, unknown to myself.

As a rule, on nine mornings out of ten, I have no recollection of having dreamed at all. That, however, did not greatly trouble me. Many people, I knew, were genuinely convinced that they never dreamed; but, from experiments I had made, I was satisfied that "dreamless sleep" is an illusion of memory. What happens is that one forgets the dreams at the very instant of waking. I myself have remembered, some days later, a dream which had occurred when I was under an anæsthetic, although, during the intervening interval, I had believed myself to have been, at the time, in a state of complete unconsciousness.

My starting-point, then, was a belief in the possibility of recalling a fraction of the lost dreams of these apparently blank nights of mine. Now, according to the new hypothesis, that fraction

should contain images of both past and future events. It was probable that the majority of such images would not be distinct and separate, but, on the contrary, so blended and intermingled that the components would not be distinguishable as belonging to any special waking event. But just as one can, occasionally, clearly identify one part of such a blend of images as relating to a particular past event (*vide* definition of "Integration" in Part I.), so should one be able, on occasion, to identify an element in the blend as pertaining to a particular future occurrence. The point was (and this is an important point) that one must not expect ever to come upon a complete idea or scene which related *wholly* to the future. As an example of what I mean, the reader may turn back to the dream of a horse, narrated in Part II. There, the greater part of the dream related to the future; but the general *appearance* of the horse, and that of the fields and railings, were, to the best of my belief, details collected from past experience.

The dream, if recalled, would, preferably, be written down, so as to make the remainder of the experiment a matter of comparison between two hard, material facts—the record and the waking event. And, to facilitate subsequent analysis of the dream images, these would best be described with as much detail as possible. A short record, full of detail, would be of more value than a long one drafted in vaguer terms.

But there was an even more cogent reason why amplitude of detail would be essential. A long dream contains a great many images, and a long day a great many impressions. By the ordinary laws of chance some of these would be bound to fit, if the experiment were sufficiently extended. Hence cor-

roborative detail would have to be the crucial test. For example, the dream of a pile of coins on a book, followed next day by the observation of a pile of coins in such a position would be the class of coincidence which would be bound to occur in any case. What would be required would be something more in the nature of a pile of *sixpences upsetting* off a *red* book, followed by such a waking experience. (The rest of the scene of such a dream—the table and the room and the cause of the mishap—would probably be entirely different; but that would not matter.) The point was that nothing should be accepted as relating clearly to the future which did not contain the elements of what a racing man would call a “double event.”

The next thing to be considered was the necessity of a time limit. Obviously, even a dream of a pile of sixpences upsetting off a red book would be likely to be matched by a similar waking experience, if one allowed oneself the whole of one's life in which to look for the matching. A bank clerk might even find fulfilment in a fortnight. I decided that two days should be the accepted limit; but that this might be extended in ratio to the oddity and unusualness of the incident. That would be a matter for judgment. My dream of the bombardment of Lowestoft, for instance, occurred a year or so before the event; and I have had one clear case—to be described later—of a dream image relating beyond all possibility of doubt to an event which happened some twenty years later.

Since, then, the possibility of satisfactory identification would depend mainly upon unusualness in the incident, the worst time to choose for the experiment would be the period when one was leading a dull life with each day exactly like the last.



But in such circumstances a visit to a theatre or to a cinema might well prove a useful auxiliary to the experiment. (That, I may say now, is an invaluable tip.) Also, one might expect to get dreams of novels one was going to read. (I may add here that one does, as a matter of fact, get some of one's best results that way.) But, speaking generally, it would be best to select nights preceding a journey or some other expected break in the monotony of circumstances.

Another factor would be evidently the *number* of the results achieved. Satisfaction might be obtained either from the previous dreaming of a single, very unusual incident; or almost equally well from the previous dreaming of several fairly unusual events, any one of which results, had it been the only one, might justly have been attributed to rather exceptional coincidence. So it was decided that all results of the singly decisive kind should be marked with a +; and that results which, though nearly decisive, required the backing of other similar results, should be marked with a sort of

hot-cross bun, thus: 

The foregoing describes the conditions I laid down for the test, and also the nature of the difficulties I was prepared to encounter. And encounter these I did, in abundance. But there were two which I did not foresee.

The dreaming mind is a master-hand at tacking false interpretations on to everything it perceives. For this reason, the record of the dream should describe as separate facts, (*a*), the actual appearance of what is seen, and, (*b*), the interpretation given to that appearance.

For example: during one of the days of the test

I happened to be blowing a wood fire with a pair of bellows, and, in so doing, I brought the nozzle of the instrument into contact with the red-hot surface (facing me) of a large log. I do not know whether the reader has ever done this; but the effect is most startling, not to say alarming. A dense shower of very brilliant sparks—a regular Crystal Palace firework display—leaps from the fire straight into your face and goes streaming past your ears, causing you to jump back for fear of being blinded. But there appears to be no heat in these sparks; at any rate, no holes are burned in your clothes. The experience is a most striking and unusual one; and, as it happened, precisely such a shower of sparks had flown past my ears in a dream during the previous night. But I had omitted to record the immediate dream-impression, which was simply that of a shower of little sparks, and had written down, instead, the *explanation* I had subsequently attached to that shower—*viz.*, that a crowd of persons who happened to be present in the dream had been throwing cigarette ends. Both aspects of the dream-incident should have been recorded: first, the image seen, and then the interpretation attached thereto. This should be done throughout all the records.

The second difficulty is one which demands careful attention. For it was here, at last, that I found the thing I had been looking for—the reason why this curious feature in the character of temporal experience has managed, through all these centuries, to escape universal observation.

The waking mind refuses point-blank to accept the association between the dream and the subsequent event. For it, this association is the *wrong way round*, and no sooner does it make itself per-

ceived than it is instantly rejected. The intellectual revolt is automatic and extremely powerful. Even when confronted with the indisputable evidence of the written record, one jumps at any excuse to avoid recognition. One excuse which is nearly always seized is the dissimilarity of the adjacent parts of the scene, or the fact that there are parts in the "integration" which do *not* fit the incident; matters which do not, of course, in the least affect the fact that there are parts of the scene or integration which *do* fit with the required degree of exactitude.

The result is that, on reading over the record at the end of the succeeding day (or two days), one is apt to read straight on through the very thing one is looking for, without even noticing its connection with the waking incident. The reading should therefore be done slowly, with frequent pauses for consideration and for comparison with the day's events. In the cases of nearly all the results I am going to relate, the connection was, at first, only half glimpsed, was then immediately rejected, and was finally accepted only on account of the accumulating weight of the previously unnoticed points of corroborative detail.

The simplest way to avoid this initial failure to notice is to pretend to yourself that the records you are about to read are those of dreams which you are *going to have* during the coming night; and then to look for events in the past day which might legitimately be regarded as the causes of those dreams. This is not unfair. It is only a device to enable you to notice; not a device to assist you to judge. That you do later, concerning yourself then solely with the corroborative details, and giving no thought to the Time order.

\* \* \* \* \*

The dodge for recalling the forgotten dreams is quite simple. A notebook and pencil is kept under the pillow, and, *immediately* on waking, before you even open your eyes, you set yourself to remember the rapidly vanishing dream. As a rule, a single incident is all that you can recall, and this appears so dim and small and isolated that you doubt the value of noting it down. Do not, however, attempt to remember anything more, but fix your attention on that single incident, and try to remember its details. Like a flash, a large section of the dream in which that incident occurred comes back. What is more important, however, is that, with that section, there usually comes into view an isolated incident from a previous dream. Get hold of as many of these isolated incidents as you can, neglecting temporarily the rest of the dreams of which they formed part. Then jot down these incidents in your notebook as shortly as possible; a word or two for each should suffice.

Now take incident number one. Concentrate upon it until you have recovered part of the dream story associated therewith, and write down the briefest possible outline of that story. Do the same in turn with the other incidents you have noted. Finally, take the abbreviated record thus made and write it out in full. Note *details*, as many as possible. Be specially careful to do this wherever the incident is one which, if it were to happen in real life, would seem unusual; for it is in connection with events of this kind that your evidence is most likely to be obtained.

Until you have completed your record, do not allow yourself to think of anything else.

Do not attempt merely to remember. Write the dream down. Waking in the middle of the night,

I have several times carefully memorized my preceding dreams. But, no matter how certain I have been that those memories were firmly fixed, I have never found one shred of them remaining in the morning. Even dreams which I have memorized just before getting up, and rememorized while dressing, have nearly always vanished by the end of breakfast.

It will be impossible, of course, for you to write down *all* the detail. To describe the appearance of a single dream-character completely would keep you busy for ten minutes. But write down the general detail, and all uncommon detail. Memorize the remainder by reading through your final record and attentively revisualizing each picture described therein; so that, should one of these unwritten details subsequently prove important, you can be satisfied that you are not then recalling it for the first time.

If, on waking, you are convinced that you have not dreamed at all, and cannot recall a single detail, stop trying to recollect the dream, and concentrate, instead, on remembering of what you were *thinking* when you first awoke. On recalling that thought, you will find that it was consequent on a dream, and this dream will immediately begin to return.

\* \* \* \* \*

Read your records over from their beginning at the end of each day of the experiment.

The sort of thing you may expect to find will be described in the next chapter.

## CHAPTER XI

THE account of the following experiments, once again, is not scientific evidence, nor is it intended to be regarded as such. It is evidence for me, and part of my excuse for publication; but it is not, of course, evidence for the reader. Conviction, for him, must depend either on the convincingness of the arguments advanced in the concluding chapters, or else on the results which, according to the theory, he is likely to obtain if he makes the experiment himself—upon himself.

Personally, I found this image-hunting a fascinating and even exciting business. But it was a new kind of sport, and I made every possible blunder open to a raw beginner. Not only did I delay the attempt to recall the dream until I had been awake for half a minute or more; but I also failed to appreciate sufficiently the importance of detail in the written accounts. Incidents which should have been described in fifty words were recorded in three. The result was that, although the dreams yielded much that was suggestive of future experience, I could find little that was *identifiable* as belonging to either half of Time. There was the shower-of-sparks dream recounted in the last chapter, and five slightly more doubtful results. There was one fully described image, the original of which was seen four years later; but that was outside the prescribed limits of the test. It was not, in fact, until the eleventh day that I got the clear, conclusive result I had expected.

On the afternoon of that day I was out shooting

over some rough country. I was a little uncertain regarding the boundaries covered by the permission which I had obtained, and presently found myself on land where, I realized, I might have no right to be. As I crossed this, I heard two men shouting at me from different directions. They seemed, moreover, to be urging on a furiously barking dog. I made tracks for the nearest gate in the boundary wall, trying to look as if unaware of anything unusual. The shouting and barking came nearer and nearer. I walked a trifle faster, and managed to slip through the gate before the pursuers came into view. Altogether a most unpleasant episode for a sensitive individual, and one quite likely to make him dream thereof.

On reading over my records that evening, I, at first, noticed nothing; and was just going to close the book, when my eye caught, written rather more faintly, right at the end:

*"Hunted by two men and a dog."*

And the amazing thing about it was that I had completely forgotten having had any such dream. I could not even recall having written it down.

There was nothing identifiable on the twelfth day; but the thirteenth gave another excellent result.

During the day I read a novel in which one of the characters hid in a large secret loft in the roof of an old house. Later on in the story he had to fly from the house, and escaped from the loft by way of a chimney.

The previous night's dream was about a large, mysterious, secret loft, which I discovered, and explored with great interest. A little later in the dream it became advisable for me to escape from

the house, and I decided to do this by way of the loft.

On the fourteenth night I had four "hot-cross-bun" results.

The net result of the experiment was that in the course of a fortnight I had been able to identify two conclusive instances of the "effect," and six which, though not conclusive when regarded singly, could scarcely be attributed to coincidence when their number was taken into account. But the most important point was this: Not one of those instances would ever have been observed at all, had not the dreams been memorized and written down, and the records reinspected after the waking events.

\* \* \* \* \*

So far, then, the theory that the effect was merely a normal characteristic of man's general relationship to Time—but one so constituted as to elude casual observation—had been partly borne out by experiment. But, on that theory, the effect in question should be just as experimentally observable to everyone else as it was to myself. This meant that I must persuade another person to make a similar trial.

A young woman, whom I will call Miss B., good-naturedly agreed to undertake the task. I selected her mainly because she was an extremely normal individual, who had never had any sort of "psychical" experience, and who (this was the great thing) believed that she practically never dreamed at all. Indeed, she assured me that it would be useless for her to experiment, as she had only had some six or seven dreams in the whole course of her life.

The morning after the first night she came to me and told me that it was quite hopeless. She



had tried to remember her dreams the very instant she woke; but there had been nothing to remember. So I told her not to bother about looking for memories of dreams, but to endeavour instead to recollect of what she had been *thinking* at the moment of waking, and, after she had got that, to try to recall *why* she had been thinking it. That worked; as I had known it would; and on each of the next six mornings she was able to remember that she had had one short dream.

Counting the experiment as starting from the first dream, she obtained, on the sixth day, the following result.

Waiting at Plymouth Station for a train, she walked up to one end of a platform and came upon a five- or six-barred gate leading on to a road. As she reached the gate a man passed on the other side, driving three brown cows. He was holding the stick out over the cows in a peculiar fashion,—as if it were a fishing-rod.

In the dream, she walked up a path she knew, and found, to her great surprise, that it ended in a five- or six-barred gate which had no business to be there. The gate was just like the one at the station, and, as she reached it, the man and the three brown cows passed on the other side, exactly as in the waking experience, the man holding out the stick fishing-rod fashion over the cows, and the whole group being arranged just like the group she saw.

The dream occurred the morning before the waking experience.

The blending of the "past" image of the path with the "future" image of the gate provided an excellent specimen of integration.

\* \* \* \* \*

I then asked my cousin, Miss C., to try. She was positive that she had never had any experience of this kind, and was sure that, as a general rule, she dreamed very little. She proved excellent at recovering the lost dreams, and good at noting detail. But at first she was very weak at perceiving connections, even with past events. She could not, for example, understand how a dream of walking on roofs could be connected with the experience of climbing about the roof of a bungalow with me on the previous day, though she had not been on a roof of any sort for years. She obtained, however, on the eighth day, the following first-class result:

Immediately upon her arrival at a certain country hotel she was told of a curious person staying there whom all the guests suspected, having made up their minds that she was a German. (This was during the last stages of the war.) Shortly afterwards she met this person—for the first time—in the hotel grounds. These are rather uncommon. They extend a long way, contain numbers of large, rare trees, and would certainly be taken for public gardens by anyone who did not know that they belonged to the hotel. The supposed German was dressed in a black skirt with a black-and-white striped blouse, and had her hair scraped back in a "bun" on the top of her head.

My cousin's dream was that a German woman, dressed in a black skirt, with a black-and-white striped blouse, and having her hair scraped back in a "bun" on the top of her head, met her in a public garden. My cousin suspected her of being a spy.

The dream occurred about two days before the event. (The record is undated, but was in my hands when the confirmatory event took place.)

She had already had one almost, but not quite, conclusive result earlier in the experiment—a dream connected with some news in a letter she subsequently received from a friend.

\* \* \* \* \*

Mrs. L., the next person to try, got an excellent result on the very first night. It related, however, to two separate experiences which occurred during the following week. The two-day limit was here exceeded; but the correspondence was so clear that the result came under the rule permitting an extension of the limit in exceptional cases.

The waking experiences concerned two public meetings at Corwen. Mrs. L. went to one of these, and, in describing it to me afterwards, told me she was surprised at the large number of clergymen who seemed to have arrived out of the void to fill the building; for it did not seem to her that there was anything in the business before the meeting which could be of special interest to the Church.

She was not present at the other meeting. But my sister was there, and she *told Mrs. L. of her experiences*. On putting her head in at the door she found a regular pandemonium in progress. She was about to withdraw discreetly, when the chairman, catching sight of her, called out: "*Come in, Miss Dunne, and see how we Welsh fight!*"

In Mrs. L.'s dream she was at a public meeting, and was greatly annoyed by the interruptions of a clergyman in the audience, who, instead of allowing the business to proceed, insisted on preaching a sort of sermon ending in a prayer. She expostulated. The clergyman leaned so far back that he touched her. Another man in the audience pushed against her arm. She rose, and, thumping a table,

cried: "Who is responsible for the behaviour of the audience? I know *the Welsh are notorious for bad behaviour in public*, but I will not have it here."

Mrs. L. forgot all about this dream after writing it down. Its record was not re-read by her after the second day, and so she missed it when the two meetings occurred later in the week. It was only by chance that I happened to look back through the notes and discover it.

\* \* \* \* \*

Major F., the next person approached, entered upon the experiment with considerable interest. He pointed out that, if there were anything in this business, it might mean the spotting of a Derby winner. He finished satisfied that I was perfectly right, but also satisfied, I am afraid, that the dreaming mind did not properly understand its business.

He happens to be a marine artist of considerable reputation; and on the second day of the test he set forth to paint a couple of boats which he had previously seen lying on the beach. But he found that one boat, *which was pointed at both bow and stern*, had been painted, since his last visit, in staring lifeboat (red and blue) colours. However, he made his sketch; a process necessitating, of course, long and close attention to the boat and its colours. The vessel stood on *short, green turf*. Some distance away, on a pier which came into the picture, was another long, red, somewhat boat-like object with *something draped across its middle*. Major F. took a field-glass to ascertain what this stuff was, and discovered it to be a *net*.

The associated dream-image was that of a *red-and-blue lifeboat standing on green turf with a net draped over its middle*.

This dream had occurred during the previous night.

Major F., at first, could not see the connection. He thought that the similarity ought to have extended to everything else in the dream scene, and was disappointed that this had not been the case. However, he continued the trial.

On the next day it rained heavily, and we both set out to look for a sheltered place from which to paint pictures. We entered a small house which was in course of construction, and, finding the view from the lower windows too restricted, erected a ladder against the cross-beams of the unfinished upper story, and climbed up on to these. The ladder was a rather unusual one, in that it had square rungs.

One of Major F.'s dreams on the preceding night had been that he was climbing a ladder which did not appear to be set against any wall. It went up, so to say, into space. And it had square rungs.

He had not been up a ladder for six years.

What finally convinced him, however, was this: He dreamed that he was sailing a toy boat with a small boy protégé of his to whom he had (actually) presented this vessel. A little later on he dreamed he saw a similar boat, but full size, dismasted, and with its sails lying flat on the water. The crew were washing them. A few days after this he heard that his boy friend had been taken to a pond to sail his new boat, but instead of doing so had insisted on removing the sails, laying them flat in the water of the pond and scrubbing them.

He agreed that these three results, taken together, were conclusive.

\* \* \* \* \*

A little while before this my brother had written to me to say that he had "got" the post-war death of General Leman, the Belgian hero, and, on opening his newspaper at breakfast, had found the announcement confronting him.

My sister, like my brother, obtained her result without the necessity of experimenting. (Both, of course, were now on the lookout for the effect.) Her evidence, however, extended into a department of science where "Beeton" is a greater name than "Newton." Here, although an ignoramus, I am humble, and so I am prepared to take her word for it that the correspondence of events in this case was sufficiently detailed to put coincidence entirely out of the question.

## CHAPTER XII

THE situation was now a little clearer. It had been discovered that the effect was one which was apparent only to definitely directed observation, and its failure to attract general attention was, thus, sufficiently explained. But the rough-and-ready method which had been devised for the purpose of rendering it perceptible seemed to work quite well. The original hypothesis of solitary abnormality had been completely killed, and, moreover, in the light of the experiment, I did not appear to possess even a specially well developed faculty for observing the effect. Those other people had got their decisive results more quickly than I, and, in most cases, those results had been clearer.

The outcome of the experiments suggested that the number of persons who would be able to perceive the effect for themselves would be, at least, so large as to render any idea of a *shared* abnormality absurd—for wholesale abnormality is a contradiction in terms. Indeed, when one came to consider, in addition, that practically everyone has occasionally experienced that queer sense of events having “happened before,” and that most people are apt to recall suddenly an apparently forgotten dream because (there can be no other reason) something occurs which reminds them of (*i.e.*, is associated with) that dream, it became fairly clear that, if there were abnormality anywhere, it would probably pertain to those, if such there should prove to be, who were mentally debarred from observing the effect. Statistics in that respect, however, could be col-

lected only from experiments conducted on a wide-spread scale consequent upon the publication of a book.

Meanwhile, the explanation seemed as far away as ever.

The trouble was that the effect was so extremely definite in its aspects. It was no broad, vague affair such as might be covered by some sweeping generalization (Relativity, for example, or a two-dimensional theory of Time); it bristled with peculiarities; it presented clues which pointed like signposts to half a dozen solutions—mostly contradictory. And, though it was easy to devise explanations which should cover some of the facts, it was difficult to find anything which could fit them all.

In the hope of obtaining additional data, I recommenced experimenting upon myself, the immediate object being to ascertain whether there were any observable differences between the images which related to the future and those which related to the past. As it turned out, the most careful observation failed to bring to view any such distinguishing features.

In the course of these further experiments, however, I came upon three dreams of a specially illuminative kind, and these, perhaps, had best briefly be described.

The first afforded a fairly clear example of an associational chain running from "past" to "future." The connecting link was the idea of *spilled ink*, which idea entered into both the related waking experiences.

*Waking experience (1): before the dream.*—Watched a friend seated at a table filling a fountain-pen, and thought he was going to spill the ink.



*Waking experience (2): after the dream.*—Read a French detective story. The detective seemed to be unusually incompetent, and, towards the end of the book, I began to wonder when he was going to exhibit some sign of the skill with which the reader had been asked to credit him.

In the *dénouement* he pretended to stumble, and, in so doing, upset some ink over a table at which the villain was seated. The latter, to save his clothes, threw himself back in his chair, raising his hands above the flood. Whereupon, the detective seized one hand and slapped it down first into the ink and then on to a piece of blotting-paper, thus obtaining a set of finger-prints. He then triumphantly denounced the criminal.

*Dream: between the two waking experiences.*—A famous detective was going to give us an exhibition of his skill. We waited a long time, but he seemed quite incompetent. Finally, he pretended to stumble, and, in so doing, spilled ink *from a fountain-pen* over the criminal, whom he then triumphantly denounced.

The second dream exhibited a similar associational chain, but in this case the link—*shooting dangerous game with a revolver*—was much clearer.

*Waking experience (1): before the dream.*—Saw pictures of a lion-shooting expedition. My brother was thinking, at the time, of joining such an expedition, and I began to wonder what guns he ought to take. While considering the merits and demerits of various weapons, was reminded of an enormous seven-chambered revolver I had seen in a Paris gun shop, which apparatus was supposed to be part of the equipment of any up-to-date hunter of lions. Wondered, with some amusement, what lion-shooting with a revolver would be like.

*Waking experience (2): after the dream.*—Read Ethel Sidgwick's "Hatchways." Two chapters are devoted to the episode of a leopard, which has *escaped from a menagerie*. It has appeared near a country house where a sort of children's school treat is in progress, and *has killed a goat*. Later on, the hero is saved from the animal by a retired explorer, who arrives in the nick of time and kills the beast with two shots from a borrowed revolver.

*Dream: between the two waking experiences.*—Looking from the windows of a country house, saw the head and shoulders of a *lion* moving through a cornfield. It was known in the neighbourhood that this lion had *escaped from a menagerie*, and that it *had killed a goat*. Wondered if I could hit it from the window with my revolver, but decided that the range was too far. Decided to lie up alongside the track in the cornfield, and wait till the beast repassed. Felt, however, that I should prefer to be armed with something better than a revolver. Went out to try to get a rifle.

The third dream provided an example of a perfect integration, the component parts of which were related to impressions received before and after the dream.

*Waking experience (1): before the dream.*—Saw in the garden of an hotel where I was staying the bottom, *minus* the sides, of an old, small, flat-bottomed boat.

*Waking experience (2): after the dream.*—My sister persuaded me to go with her to one of the Olympia motor cycle shows, as she wanted my opinion on a small "scooter" which had caught her fancy. It was a neat-looking little thing called the "Unibus," and it was entirely different to the other scooters in the show, inasmuch as it was built on

motor-car principles, with shaft, gear-box, etc. It was equipped with a little seat of curious shape (on all scooters that we had seen hitherto, one stood on the base-board). Also, it was fitted with a shield for the protection of ladies' dresses. I pointed out the advantages of this last feature, and added that in ordinary scooters she would get her feet horribly wet and muddy. As I said that, there flashed through my mind the old curious conviction: This has happened before. Knowing what that meant, I set to work and presently revived the lost memory. It belonged to a dream, and what was more, a dream which I had recorded. On my return home I looked up the notes, and found that they had been made *two years before*.

*Dream: between the two waking experiences.*—Saw my sister coming down a street, sitting in an extremely curious little motor-car. (I had made a sketch of this machine, which was simply the "Unibus," without its shield.) Called out to her something about getting her feet wet. Saw water in the roadway up to the level of the low, oval platform.

The notes stated that the platform of this tiny car was *the piece of a flat-bottomed boat* I had seen nine or ten days before.

Since we have got on to the subject of long-range association with a dream in the middle, I may as well describe the most perfect example of the kind I have ever experienced. The gap between dream and future event was about twenty years.

*Waking experience (1): before the dream.*—When a small boy, between twelve and fourteen, I read with enormous interest Jules Verne's "Clipper of the Clouds." Readers of that book will probably remember the illustrations of the author's idea

of a flying machine. These showed a long, dark hull of about the size and shape of a modern "Destroyer," except that it had a ram bow. This thing, which looked as if it had got off the sea and into the air by mistake, was supported solely by a cloud of tiny screw propellers mounted on a forest of thin metal masts. There were no wings, or anything of that sort.

*Waking experience (2): after the dream.*—Some twenty years later, in 1910, I made the first decisive flight in the first aeroplane which possessed complete inherent stability.\* It was a rather exciting episode. The thing got off too soon, bounced—and, when I recovered my scattered wits, I found it roaring away over the aerodrome boundary, climbing evenly, and steady as a rock. So I left well alone, and allowed it to look after itself. This it did till the engine gave out (usually a matter of three minutes in those days). The sensation was most extraordinary. The machine, like all those of my design, was tailless, and shaped, as viewed from below, like a broad arrow-head *minus* the shaft. It travelled point foremost, and, at that point, there was fitted a structure like an open (undecked) canoe, made of white canvas stretched over a light wooden framework. Seated idly in this, and looking down over the sides at the cattle scampering wildly around three hundred feet below, the whole of the main structure of the aeroplane was away back behind the field of vision, and the effect produced was that one was travelling through the void in a simple open canoe.

*Dream: between the two waking experiences.*—

\* Mr. L. Gibbs had previously persuaded a similar machine of my design to leave the ground; but the flight on that occasion was limited to a few yards.

A few days after I had read, as a small boy, Jules Verne's book, I dreamed that I had invented a flying machine, and was travelling through space therein. It must be borne in mind that I had never heard of, or conceived the possibility of, any flying machine different to the great metallic, screw-supported "clipper of the clouds." Yet in my dream I was seated in a *tiny open boat constructed of some whitish material on a wooden framework*. I was doing no steering. And there was no sign of anything supporting the boat.

I may add here that the boat-like *nacelle* of the "Dunne" biplane had not been added on account of any lingering, unrecognized memory of the dream. The earlier machines had no such feature. This had been attached as an afterthought, simply in order to reduce the "head-resistance" of the pilot, which resistance, at that particular place, was believed to exercise a detrimental effect upon the stability of the apparatus.

I never forgot that dream, and recalled it with amusement when, in 1901, being on sick-leave from the Boer War, I set to work in earnest to devise some "heavier-than-air" contrivance, which should solve the great military problem of reconnaissance. But it seemed to me a dream natural enough for a boy, and I did not then perceive the significance of the *appearance* of the dream-machine—indeed, I could not do so, for the related constructional development did not come till ten years later. By then I had dismissed the dream as of no importance, and it was only recently that I realized that the corroborative detail of the little, white, open boat classified the whole as an "anticipation" of "future" experience.

\*

\*

\*

\*

\*

Granted that the dreaming attention ranges about the associational network without paying heed to any particular "present," there is nothing astonishing in its lighting on an image many years "ahead." This, in fact, is exactly what we should expect, for in its "backward" travel it often lights on images many years "behind."

But, when it comes to computing the proportion which the images of the past bear to the images of the future, in a given series of dreams, one is apt to be misled. For the images which relate to events a long way behind can be recognized and counted; but those which relate to events similar distances ahead cannot be identified. Hence, the only way to strike a balance is to confine the statistics to the range of a few days either way. Images which relate equally well to either past or future—such as those of friends, and of everyday scenes—should not be counted. Images which are apparently of the past should be submitted to the same severe scrutiny as are those which are apparently of the future, for coincidence will operate just as effectively in either direction.

Computing in this fashion I have found that the images which relate indisputably to the near-by future are about equal in number to those which pertain *similarly indisputably* to the near-by past.

## CHAPTER XIII

WHY only in dreams? That was the question which blocked all progress. Every solution which could reduce Time to something wholly present ruled that the pre-images should be just as observable when one was awake as they were when one slept. So, why only in dreams?

I should be ashamed to confess how long a period elapsed before I saw that, in framing that question, I was *begging the question*. The moment, however, that I did realize this, I proceeded to put the matter to the test.

A little consideration suggested that the simplest way to set about a waking experiment would be to take a book which one intended to read within the next few minutes, think determinedly of the title,—so as to begin with an idea which should have associational links with whatever one might come upon in that future reading,—and then wait for odds and ends of images to come into the mind by simple association.

Obviously, one could save a lot of time by rejecting at once all images which one recognized as pertaining to the past. Also, since the images would be perceived while awake and with one's wits about one, one might rely more upon one's memories of them than one could when the memories were formed sleeping, and thus save a vast amount of writing. A brief note of each image should suffice.

The first experiment was a gorgeous success—until I discovered that I had read the book before.

It was interesting, however, as showing the

tremendous difficulty the waking mind experiences in freeing itself from its memories. I spent by far the greater part of the time in rejecting images of the past and starting afresh with a mind comparatively blank.

Apart from the items which related to the book (already read), I got only a few ideas, mostly concerning London and the exterior and interior of clubs. The only exception was the single word "*woodknife*," which drifted into my mind, seemingly, from nowhere. A little reflection satisfied me that I had never in my life come upon such a word, so I jotted it down.

Two or three days after this I moved, quite unexpectedly, to London. On my arrival, I went to my club, and having for the moment nothing better to do, proceeded to the library, picked out a newly published novel, and tried a second experiment. Result—nil. In fifteen minutes I got only eight images, which did not clearly belong to the "past" half of the associational network. One of these eight related to a *kangaroo hunt* in Australia—riders and hounds chasing pell-mell after the leaping animal. Another comprised the single word "narwhal." There was nothing in the book that fitted, and presently I threw it aside.

I then drifted into a little inner library, which is an excellent place for a nap. I chose a comfortable armchair, and, for appearances' sake, equipped myself with another volume—R. F. Benton's "*Book of the Sword*," opening this in the middle.

Immediately my eyes fell upon a little picture of an ancient dagger, underneath which was inscribed "*Knife (wood)*." I sat up at that, and began to dip into the book, turning back after a moment to page 11. There I came upon a reference to the



horn of the narwhal. Reading on, I found on the succeeding page the words, "*The 'old man' kangaroo, with the long nail of the powerful hind leg, has opened the stomach of many a staunch hound.*"

Now, there was nothing conclusive here, but it was just the sort of suggestive but uncertain thing one keeps on getting throughout the dream experiment, while one is waiting for one's decisive result. I was, therefore, encouraged to proceed.

I tried next with Baroness van Hutten's book, "Julia." Result—a quarter of a sheet of notepaper of material, the only thing that fitted being "*pink house,*" there being a reference in the book to "*pink houses.*" (Not good enough.)

Arnold Bennett's "Riceyman Steps" served for the next experiment. I got only three lines of material, but these contained the words, "*I am entitled to say.*" On opening the book I found in the first paragraph the words, "*The man himself was clearly entitled to say.*"

Then I tried with Mason's "House of the Arrow." Here I altered the procedure. I opened the book at the beginning, and found the name of one of the characters, being careful not to glance at any other page. It seemed to me that a name which would be likely to occur in close connection with many of the incidents of the story would provide a better associational link than does the mere idea of the book's title.

I do not know if the present reader is acquainted with the "House of the Arrow," and, if he is not, I am most unwilling to spoil for him, even in the interests of science, the enjoyment of a first-class detective story. So I will merely say that the centre knot of the whole tangle—the thing upon which everything in the plot hangs—is a clock pointing to

*half-past ten.* This feature, however, does not come into the story till halfway through the book.

The character I had chosen from the opening pages as an associational link accompanied the detective throughout the latter's investigation. Concentrating attention on that character, the first image I saw and noted was that of *a clock pointing to half-past ten.*

With Lord Dunsany's book, "The King of Elfland's Daughter," I got "*Long cliffs of crystal looking over dark sea. Fireflies dancing over this sea.*" Not a bad description of the night scene pictured in the book, where the long crystal cliffs look down upon a mist-covered plain over which the lights of Elfland are dancing, advancing, and receding.

I then tried a book of Snaith's, taking the heroine's name as an associational link. Here I failed completely. But, in the middle of this experiment, I got one very curious image.

It was that of an umbrella with a perfectly plain, straight handle, a mere thin extension of the main stick, and of much the same appearance and dimensions as the portion which projected at the ferrule end. This umbrella, folded, was standing unsupported, *upside down, handle on the pavement*, just outside the Piccadilly Hotel.

I happened to pass that way in a bus next day. Shortly before we got to the hotel I caught sight of a most eccentric-looking figure walking along the pavement in the same direction, and on the hotel side of the street. It was an old lady, dressed in a freakish, very early-Victorian, black costume, poke bonnet and all. She carried an umbrella in which the handle was merely a plain, thin, unpolished extension of the main stick, of much the same

appearance and dimensions as the portion which projected at the ferrule end. She was using this umbrella—closed, of course—as a walking-stick, grasping it pilgrim's-staff fashion. But she had it *upside down*. She was holding it by the ferrule end, and was pounding along towards the hotel with *the handle on the pavement*.

I need hardly say that I had never before in all my life seen anyone use an umbrella that way.

\* \* \* \* \*

These experiments showed me that, provided one were able to steady one's attention to the task, one could observe the "effect" just as readily when awake as when sleeping. But that steadying of attention is no easy matter. It is true that it makes no call upon any special faculty, but it does demand a great deal of practice in controlling the imagination. Hence, to anyone who is desirous merely of satisfying himself as to the existence of the "effect," I should recommend the dream-recording experiment in preference to the waking attempt.

But, for *studying* the problem, the waking experiment is of distinct value, because one can follow a great deal of what one's mind is doing. Also, there is no dream-story to complicate matters.

In my own case, I employed this experiment mainly in order to seek for the *barrier*, if any, which divides our knowledge of the past from our knowledge of the future. And the odd thing was that there did not seem to be any such barrier at all. One had merely to arrest all obvious thinking of the past, and the future would become apparent in disconnected flashes. (For, however difficult and troublesome the process, that was what, ultimately, it resolved itself into.) Yet, if one tried to follow

up the "memory train" from past to future, one came, not so much to a resisting barrier, but to an absolute blank. Moreover (and this I discovered by separate experiment), if one allowed the attention to pass from the image under consideration to another which was *manifestly* associated therewith, one remained, so to say, in the "past" part of the network. There, attention was completely at home. The associated images followed one another in swift, easy succession; attention ran on and on without noticeable effort or fatigue.

It was only by rejecting manifest associations with the last image, and waiting till something apparently *disconnected* took its place, that attention was enabled to slip over the dividing line.

## CHAPTER XIV

THERE remains one more dream to be described. While not, perhaps, completely conclusive, it was so nearly so that it had to be taken into serious account. And since, if it really did relate to the future, it could not possibly fit in with the solution I happened to be favouring at the time, it caused me to abandon work on those particular lines, and to hark back to an earlier theory. And this, as it turned out, was wholly fortunate.

On the morning after the dream I was, while dressing, engaged in following up a long train of reminiscences of my school days—a train which led, in perfectly logical sequence, to the memory of an adventure with a wasp. As a boy I was terrified of these insects, and could hardly bring myself to remain in the same room with one. Imagine my horror, then, when, during a meal in a room with an open window, a large wasp entered, flew to me, settled on my neck and proceeded to crawl round deep down inside my Eton collar. I sat there, white as the tablecloth, while a master adjured me, quite unnecessarily, not to move. To this day I can remember the horrid sensation of the insect's soft, faintly felt perambulations. And so, forty-four years later, on this particular morning, when my train of thought had brought me to that early memory, I tried to recall the feel of those crawling feet. As I did so I happened to be combing my hair; the comb caught at a particular place on the crown of my head, and instantly there came back to my mind a dream of the previous night. I had

dreamed of that feeling of something catching in my hair at that precise point of my scalp, had been convinced that *a wasp was crawling there*, and had called to a companion to take it off.

Now, assuming that this was an anticipatory dream—an instance of the “effect”—we have the following facts to consider.

The simultaneous presentation to consciousness of the sensory impression of the comb in the scalp and the memory image of the feel of the wasp's feet, was a straightforward enough example of the process of forming an association by “contiguity.” And, *before that association had been formed*, it was presented in the dream in the shape of an integration.

A very pretty mixture of experience.

## PART IV

### CHAPTER XV

BEFORE we begin to look for an explanation, it might be as well for us to glance, briefly, at what precisely it is that we have to explain.

First, of course, there is the "effect" itself—the apparent temporal disorder of the presentations. The actual order of experience, such as might be recorded in a diary, runs thus :

- $a'$  a pre-presentation of  $A$ .
- $a''$  a re-presentation (memory) of  $a'$ .
- $A$  a presentation.
- $a$  a re-presentation of  $A$ .

If we accept the evidence afforded by the dream described in the last chapter, the matter becomes more complicated in this respect : It looks as if  $A$ , in the above list, might be *any* sort of compound of presentations.

Next, we have the following to consider :

As the result of observing an image of future experience, the experimenter takes pencil and paper, and notes down, or even makes a sketch of, the details of the pre-image observed. In so doing, he is performing a definite physical act. *But it is an act which would never have been performed had he not observed that pre-image.* In other words, he interferes with that particular sequence of mechanical events which we postulate as the backbone of our "conscious automaton" or materialistic theories.

This is barefaced "intervention." But it implies something more. These future events are, at any rate, real enough to be experienced as pre-presentations; yet—since, as we have just seen, the observer can alter his course of action as the result of his pre-observation—they are events which, theoretically, may be prevented from happening. Are we, then, to say that they are only partly real—less real, for instance, than are past events? That is another question our explanation has to answer.

Furthermore, this ability of the observer to interfere with the course of brain events introduces the question of "free-will." Our solution will have to make a satisfactory statement in that connection.

Finally, it is essential that the explanation does not contradict the already known facts of psychology and psychophysics. And of those facts there are some which greatly limit our range of permissible speculation. On the psychical side we have the fact—dwelt upon in Chapter XIII.—that the memory "*train*" does not run through into the "future." It ends in the "present." On the psychophysical side we have all that is included in the usual evidence for parallelism, and, in particular, the known fact that concussion of the brain apparently destroys or paralyzes recently formed memories. There can be no question but that here something more than a mere "motor habit" is affected: the patient's mind with regard to such immediately previous events seems to be a complete psychological blank.



## CHAPTER XVI

It is worth noting that Relativity admits of "seeing ahead" in Time, in the sense that what is future to Jones may be present to Brown. But it does not admit of an event in the remoter future of Jones appearing to Jones a day or two before an event in his nearer future. And that is our problem.

\* \* \* \* \*

It must be borne in mind that material records are indications of the *past* only, so far as the thing on which those records are imprinted is concerned. If, on inspecting a target at a given instant, you perceive a round, punctured hole in the corner, you may infer that a bullet has passed through at that point. But nowhere does that target offer you any indication that another puncture is presently going to appear therein—at, say, half an inch from the centre of the bull's-eye. It is true that, from a complete knowledge of all the mechanical movements which were going on in that quarter of the universe at the moment of your inspection, you might, if you were possessed of some sort of superlative intelligence, be able to deduce that a bullet would shortly strike the bull's-eye at the point in question. But that is to confuse the issue. It is to introduce a host of indications *external* to the one we are considering—which one is the state of the target. That state offers no indication concerning the coming puncture. So uncommunicative is it that, in working out your prophecy, you would leave the question of present damage or lack

of damage entirely out of consideration: it could not affect your decision. The *target* contains no "record" of its own future—the indications you use are, in fact, everywhere *except* on that surface. But the punctured corner of the target is a record of the past history of the target; and it is from that record, and not from a knowledge of what exactly was going on throughout the whole of that quarter of the universe at some earlier moment of Time, that you deduce the past impact of the bullet.

Punctures in the target are indications of the future, in the sense that they are evidence of the directions which the bullets may be taking, and so indications of what may be going to happen to the stop-butts at the back of the target; but they are not indications of future punctures in the target itself.

Now, the brain is a material organ, and the state of the brain at any given instant is no more an indication of what the world outside the brain is going to present to that brain in the future than is the state of our target an indication of where the next bullet is going to strike, or whether a new one is going to strike it at all.

## CHAPTER XVII

It is never entirely safe to laugh at the metaphysics of the "man-in-the-street." Basic ideas which have become enshrined in popular language cannot be wholly foolish or unwarranted. For that sort of canonization must mean, at least, that the notions in question have stood the test of numerous centuries and have been accorded unhesitating acceptance wherever speech has made its way.

Moreover, the man-in-the-street is, all said and done, *Homo sapiens*—and the original discoverer of Time. It was from him, and from him alone, that science obtained that view of existence.

His conclusions regarding the character of his discovery seem to have been very emphatic in detail, if slightly uncertain in synthesis. His idea was that temporal happenings involved *motion in a fourth dimension*.

Of course he did not *call* it a fourth dimension,—his vocabulary hardly admitted of that,—but he was entirely convinced:

1. That Time had length, divisible into "past" and "future."
2. That this length was not extended in any Space that he knew of. It stretched neither north-and-south, nor east-and-west, nor up-and-down, but in a direction different to any of those three—that is to say, in a fourth direction.
3. That neither the past nor the future were observable. All observable phenomena lay in a field situated at a unique "instant" in the Time

length,—an instant dividing the past from the future,—which instant he called “the present.”

4. That this “present” field of observation *moved* in some queer fashion along the Time length; so that events which were at first in the future became present and then past. The past was thus constantly growing. This motion he called the “passage” of Time.

There is a point here worth noting—a point which we shall have to discuss more fully later on. An examination of the last paragraph will show that many of the words therein refer to *another* Time, and not to the Time stretch over which the passage of the “present” field of observation was supposed to take place. This, perhaps, will be more readily seen if the paragraph be repeated with the words in question italicized.

4. That this “present” field of observation *moved* in some queer fashion along the Time length; so that events which *were at first* in the future *became* present and *then* past. The past was thus *constantly growing*.

The employment of these references to a sort of Time behind Time is the legitimate consequence of having started with the hypothesis of a *movement* through Time’s length. For motion in Time must be timeable. If the moving element is everywhere along the Time length at once, it is not moving. But the Time which times that movement is another Time. And the “passage” of that Time must be timeable by a third Time. And so on *ad infinitum*.\* It is pretty certain that it was because he had a vague glimpse of this endless array

\* This, of course, has been pointed out before now— as an objection to the Newtonian idea of a Time which flows.

of Times, one, so to say, embracing the other, that our discoverer abandoned further analysis.

But he adhered to his two main conceptions—the Time length and the Time motion. And he coined special phrases with which to convey to his entirely comprehending companions those two very practical and useful ideas. He spoke of a “long” Time and a “short” Time (never of a broad or narrow Time). He referred to the “remote” past and the “near” future. He said, “when tomorrow comes,” and, “when I get to such and such an age.” In his more poetical moods, he declared that Time “flew,” and that the years “rolled by”: he wrote of “life’s journey,” and of living “from day to day.”

He symbolized this general conception of Time in several ways; most exhaustively, perhaps, in his sheets of piano music. In these, the dimension running up-and-down the page represented Space, and intervals measured that way represented distances along the instrument’s keyboard; while the dimension running across the page from side to side represented the Time length, and intervals measured that way indicated the durations of the notes and of the pauses between them. But that did not complete the symbol. So far, the page represented merely what we should, to-day, call a “Space-time continuum.” In order to complete the symbol, it was intended that the player’s point of vision should *travel* from left to right along the model Time dimension, and that the written chords should be played as this moving point, representing the moving “present,” reached them.

In another case the Time dimension was represented by the circumference of a circle, this length

being marked off into portions representing Time distances. But that alone did not suffice to convey his conception of Time. There was no moving "present." So he added a pointer to represent this "present," and set it moving over the symbolical Time dimension by means of machinery. The entire contraption was then not only a symbol, but an actual working model of Time as he conceived it. It was an extremely useful device; and he called it a "clock."

Now, a clock-face without hands; a sheet of music which directs that all the chords are to be played with one resounding crash; and the concept of a Time length in which every part is equally present to a seventy-year-long observer: these three things are, to the man-in-the-street, exactly equivalent in value.

For he did not conceive Time as having length (or infer that Time had length) save for some very good and quite imperative reason. Nor is that reason in any way hidden or obscure. We all perceive phenomena as being arranged in two sorts of order. There are those which appear to be merely separated in Space, and those which appear to be "*successive*." That difference is "given"; it is there; it confronts us, do what we will, or think how we may. We must have conceived or perceived that Time had length merely as part and parcel of an attempt to account for this apparent *succession* of phenomena. So it would have been equally part and parcel of that attempt that the Time length should be regarded as a length moved-over, a dimension in which we travelled from second to second, from hour to hour, from year to year, thus coming upon the Time-separated events one after the other, just as we come upon objects in our mundane jour-

neys. The original concept must have appeared as a single one—that of length-moved-over. That the two component ideas in this complex—Time length and Time movement—may possess any analytical value regarded *entirely* apart from each other, demands a considerably more advanced power of reasoning.

It was not until comparatively recent years that it seems to have occurred to anyone that the man-in-the-street's imagined, but unchristened, fourth dimension might prove to be a "real" fourth dimension, akin to any of the three dimensions of Space. D'Alembert (1754) wrote of a friend of his who had conceived this notion.\* But the earliest printed treatise on the subject that I can discover is a monograph by C. H. Hinton entitled, "What is the Fourth Dimension?" and published in 1887.

Hinton described a little model system of lines sloping in different directions but supposedly all connected to a rigid framework. If this framework with its fixed, slanting lines were to be passed slowly downward through a fluid plane which stretched at right angles to the direction of the motion, "there would be the appearance of a multitude of moving points in the plane, equal in number to the number of straight lines in the system." If solid threads of matter were substituted for the lines, these moving points (cross-sections of the threads) would appear as moving atoms of matter to an imagined two-dimensional being inhabiting the fluid plane and regarding it as all the Space there was. Similar considerations would hold good for an arrangement of four-dimensional threads of matter passing through three-dimensional Space. "Were such a thought adopted, we should have to imagine some stupendous whole, wherein all that *has ever come into being or will come co-exists*, which, passing slowly on,

---

\* I am indebted to Mr. Edwin Slosson for this piece of information.

leaves in this flickering consciousness of ours, limited to a *narrow space* and a *single moment*, a tumultuous record of changes and vicissitudes that are but to us." The italics are mine.

Readers who are not used to visualizing geometrical figures may find Hinton's description a little difficult to follow. It might be as well, therefore, to present the idea in a rather simpler form, and to illustrate this by means of a diagram. But, before we do so, a word or two of explanation regarding Time diagrams in general may not come amiss.

A dimension is not a line. It is any *way* in which a thing can be measured that is *entirely different* from all other ways. In geometry we are measuring a fundamental thing called "*Extension*"—a thing which is simply the formal opposite to nothingness. We find that, if we set about measuring this in ways which appear to be each totally different from all the others, these ways must appear to be each at *right angles* to all the others. Thus, if we choose to start by regarding north-and-south as one way (one dimension), we may consider east-and-west as another way, because we can measure off distances east-and-west without ever moving northward or southward at all. A third way in which we could measure without infringing on the other two ways is up-and-down. If Time has length,—which is extension,—then Time provides us with a fourth way, for we could measure along Time without moving in any of the dimensions already mentioned. A fifth way . . . but we have, as yet, no *names* for any other ways. Yet, theoretically, there may be an unlimited number of such ways, each at right angles to all the others. Mathematicians think nothing of considering ten of them. But we cannot *visualize*



more than three at a time, because our bodies and brains are machines which are not constructed to work in more than three dimensions.

When it comes to drawing diagrams, we find ourselves limited to the use of the two dimensions in which the paper is extended—viz., up-and-down and from side-to-side. But we may use these two dimensions to represent *any* two dimensions we please,—the fourth and the fifth, for example, or the first and an imagined one-hundredth,—because, whichever two dimensions we choose to represent, these must be at right angles to each other in exactly the same way as are the dimensions of the paper. Thus, we can say that one dimension of the paper represents Time, and the other a dimension of Space, and thus draw diagrams exhibiting the relation of real Time to this Space dimension. For, if Time is really extended (has length), it would be possible for the diagram to be placed, in exactly that fashion, in a plane which extended one way in Time and the other way in Space.

But what about the remaining two dimensions of Space? Well, one of them may be considered as standing out at right angles to the plane of the paper, and may even, if you like, be shown in a perspective view. The other cannot be shown at all, or even imagined. You merely know that it must be *considered* as extending at right angles to the other three. But the simpler kinds of Time diagram deal with problems in which the consideration of more than one or two dimensions of Space is unnecessary.

In the present diagram, we shall consider the side-to-side dimension of the paper as representing Time, and the up-and-down dimension as representing Space. In order to avoid all chance of any

reader confusing a dimension with a line, I propose to place a little dimension-indicator in the corner of the picture, just as a cartographer places in the corner of his map a little diagram showing the points of the compass. Time will be indicated by  $T$ , and Space by  $S$ .

Here, then, is Hinton's idea, pictured in two

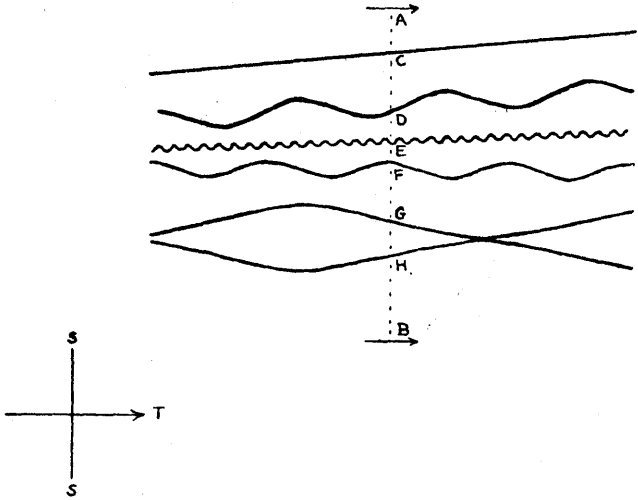

FIG. 1.

dimensions, but with lines of a rather more varied character than had those which he took into consideration.

The full lines represent material threads extending (enduring) in Time. If you examine any one of these lines, you will notice that the points of which it is composed are placed at different positions in Space (different heights in the page) at different moments in Time (different distances from the margin). The dotted line AB represents a section

of what Hinton called a "fluid plane" (you may imagine the rest of it as sticking out at right angles to the paper, though that is quite unnecessary). The arrow-head to the T in the little dimension-indicator shows that AB is to be regarded as moving, without tilting one way or another, straight along the Time dimension. The arrows at the top and bottom of the moving line are merely there to reinforce this idea. They will be omitted, as a rule, in subsequent diagrams.

If AB were to travel thus, the little bits of the full lines, where these are intersected at C, D, E, F, G, and H, would appear as moving either towards A or towards B—as moving, that is to say, in Space. (If you will cut, in a piece of paper, a fine slit to represent AB, lay this on the diagram with the slit parallel to AB, and then slide the paper in the direction of the arrow, you will see these apparent movements with great clearness.)

A creature whose field of observation was thus limited to AB would be aware, therefore, of a little world of moving particles. But you and I, whose field of observation covers the whole diagram, perceive that the *actual bits* of the full lines intersected do not really move about on the page: what happens is merely that the sectional *views* of the lines move as our eyes follow the movement of AB. And the only thing which seems to us to really move over the page is the line AB.

So, according to Hinton's theory, a being who could see Time's extension as well as that of Space would regard the particles of our three-dimensional world as merely sectional views of fixed material threads extending in a fourth dimension, and would consider that the only thing in the entire Cosmos that really moved was that three-dimensional field

of observation which we call the "present moment."

Hinton thus assumes that the past and the future "co-exist," and that our experience of change is due to a relative motion between this Time extension and that "narrow space and a single moment" which is the present. But he refrains from noting that such relative motion must *take Time*.

As a contribution to the subject, Hinton's exposition was remarkable, in that it clearly indicated the part that must be played by matter in any careful interpretation of the man-in-the-street's vague idea. According to Hinton, matter, as exemplified by his "threads," *extended* in the Time dimension.

The man-in-the-street has never definitely carried his analysis thus far. To him, it seems essential that something should move in Time; but there is no evidence that he has ever realized that there would be a vast difference between (a) a system in which his three-dimensional field of observation moved through a stationary world of four-dimensional matter, and (b) a system in which he and a three-dimensional material world moved together, *en bloc*, through a blank.

The latter concept is, of course, entirely devoid of meaning. Its acceptance may, in fact, be said to constitute the great Time Fallacy. Movement of the universe *as a whole* through a thousand such featureless dimensions could not make the slightest difference to what was going on in that universe: it could not explain or account for any phenomenon whatsoever, temporal or otherwise. There would be no change, no experience of succession, which would not be equally apparent in the absence of that supposed motion. *Nor would the concept of such a motion amplify or abstract from any concepts that*

*you can entertain without thinking of such a motion.*

The man who allows himself to drift unwittingly from his original concept of an occupied Time,—a dimension in which he travels from event to event,—and who begins to entertain in its place the meaningless idea of his travel through an empty and ineffectual continuum, seldom proceeds very far in his thinking before, perceiving the nonsensicalness of his new idea, he decides that “there is no such thing as Time.”

## CHAPTER XVIII

To Hinton there was no qualitative difference between the Time dimension and the dimensions of Space. He *started* with four dimensions of Extension, all fundamentally alike, and his problem was to discover why any human being should regard one of these as specially distinguished from all the others. He found his answer in the idea of a three-dimensional field of observation moving up the four-dimensional block. This, it will be noted, made the apparent Time dimension the same for all observers, no matter which way the bundles of material threads representing their bodies happened to be inclined in the whole dimensional extension. His travelling field would, thus, be a constituent of the universe which existed independently of the existence of any individual observer.

Mr. H. G. Wells took a slightly different view. And, in the "Time Machine," published seven years later, he, through the mouth of one of his fictional characters, stated his case with a clearness and conciseness which has rarely, if ever, been surpassed.

He begins by insisting on the *necessity* of regarding Time as a fourth dimension. (Hinton had not perceived this.) It is a way in which matter *must* be measured.

"There can be no such thing as an instantaneous cube . . . any real body must have Length, Breadth, Thickness, and . . . Duration."

Matter, thus, for him, as for Hinton, extends (endures) in Time.

"For instance, here is a portrait of a man at eight years old, another at fifteen, another at seventeen, another at twenty-three, and so on. All these

are evidently sections, as it were, Three-dimensional representations of his Four-dimensional being, which is a fixed and unalterable thing."

(The portraits in question would have needed to be sculptured, three dimensional figures. But the meaning is clear.)

He emphasized and re-emphasized the fact that there was no qualitative difference between a Time dimension and a Space dimension. There was an apparent distinction, drawn by the observer, but no such distinction if you left the observer out of it.

"There are really four dimensions, three of which we call the three planes of Space, and a fourth, Time. There is, however, a tendency to draw an unreal distinction between the former and the latter, because it happens that our consciousness moves intermittently in one direction along the latter from the beginning to the end of our lives."

A little later on, he refers to the Time-moving elements as "our mental existences." Note the use of the plural. There is no all-embracing moving *stratum*, filling Space between the different observers, but a number of "mental existences," one for each observer, and it is the motion of these which alone determines which dimension is Time.\*

Now, that statement implies something which Wells did not specifically mention. Each of such mental existences would be centred in or about the corresponding observer's brain, and so, in its travel, would be bound to follow whatever bundle of fixed lines in the four-dimensional extension represented that brain. Hence, if it were the travel of the

\* In the story which follows, the hero is granted an amount of geometrical freedom considerably greater than such a theory would allow. But that—to the reader—is a matter for rejoicing rather than complaint.

“mental existence” which caused the observer to make an artificial distinction between Time and Space, each observer would regard Time as *stretching in the direction in which his body line extended*. It would follow that his body line would seem to him to be running *straight* up this Time dimension of his, and not to be bending this way and that in Space—*i.e.*, sitting in a railway train, he would seem to himself (until he began to speculate about it) to be at rest.

Moreover, the body lines of different observers are never parallel. Our bodies do not remain a constant distance apart from one another in Space. Therefore, different observers would hold slightly differing opinions as to the correct directions of the Time and Space dimensions.

For the rest, we may note, that, like Hinton, Wells fails to mention that anything which moves in Time must take Time over its movement.

\*            \*            \*            \*            \*

“Relativity” is a *particular* theory grafted on to the *general* theory of Time-dimensional universes. Consequently, its survival or demise cannot affect the validity of that general theory.

The Relativitists exactly reversed the procedures of the nineteenth century Time-dimensionalists. Certain apparent anomalies in certain optical experiments led Einstein to enunciate, for the first time in history, the idea that different individuals might hold different views regarding both Time (as told by clocks) and Space (as measured by rods). From this, Minkowski deduced the existence of a four-dimensional extension in which there was no qualitative distinction between the dimensions, but only an apparent distinction, each observer regarding



Time as stretching in the direction of his own, apparently straight body-line.

But Einstein's theory embraces a further supposition; one which, unfortunately, removes the subject to regions largely beyond the comprehension of the man-in-the-street. This "Space-Time" extension is said to be not "flat," but "curved."

Neither of these Relativist additions have any determining influence upon the broader doctrine with which we shall be concerned in this book,—a doctrine which relates to Time-dimensional theory in general,—and the reader may accept or reject the Einstein teachings without committing himself to agreement or disagreement with anything in the following pages.

The extensions of Time-extended objects are usually, in Relativity theory, called "*World lines*"; but they are sometimes referred to as "*Tracks*." "An individual," says Professor Eddington,\* "is a four-dimensional object of greatly elongated form; in ordinary language we say that he has considerable extension in time and insignificant extension in space. Practically he is represented by a line—his track through the world." The addition of those last five words to an otherwise perfectly complete statement may seem to the reader something akin to "hedging"—for how can the line be both the observer and the observer's path? But Eddington, a little farther on, is at pains to make his own view clear. The "track" of the (presumably physical) observer is that observer "*himself*." The italics are Eddington's own. And, again, lower down on the same page, he remarks: "A natural body extends in time as well as in space, and is therefore four-dimensional."

\* "Space Time and Gravitation," p. 57.

This seems plain enough. To any specific observer contemplating such a system of fixed, objective lines, the appearance of motion in the dimensions representing Space could be produced, as in Hinton's model, by the real movement, along the observer's "track" of a field of observation apparently at right angles to the dimension representing Time. But to suggest anything of that kind would be to hint that this Time-travelling field of observation pertained to a *psychical* observer. For the physical observer is already defined as the "track" travelled over.

Now, the Relativist has a very difficult case to present, and he certainly does not want to be handicapped with the burden of a psychical observer. On the other hand, he does not wish to appear to ignore the fact that we observe events in succession. It is this quandary which drives him to a statement which appears to be intended as non-committal. The "observer" is said to move along his "track," and the reader is left to infer what he pleases from that.

Unfortunately, however, the reader has usually been allowed to infer that by "observer" is meant a physical apparatus, inorganic or organic. So he can hardly be blamed for supposing that he is intended to understand that the "track" is formed merely by the peculiar warpings of the Relativist's "Space-Time," and that the physical elements of the observer's body move over the tracks, leaving these empty before and behind.

If, however, he were to assert that this is the teaching of Relativity, he would be told that a track which possessed reality in such a sense and to such an extent as to account for all the physical characteristics of an imagined three-dimensional object

moving along it would be, in every one of its cross-sections, *physically indistinguishable* from the imagined object itself. Physically, the track would actually *be* the object extended in Time.

And that is the crux of the whole business. Anything that could properly be regarded as moving along the track would have to be something different from the fixed sections of the track itself.

The Relativitists, having committed themselves to the idea of motion along these Time-extended tracks, find themselves, like everybody else, compelled to consider that conception of a Time embracing Time which must always accompany the idea of anything moving in Time. Here, their habit of writing of the tracks, sometimes as *extensions* of physical objects, and at other times as the *paths* of travelling, non-extended, physical objects—of writing, in fact, as if the two conceptions were identical—seems to lead them into some confusion. They speak of clocks, physical instruments, as moving along the tracks, and as recording the rates of their progress. But the clock is, physically, a bundle of the tracks, and cannot move over itself. While, psychologically, it is merely a moving cross-sectional *view* of that bundle of tracks, and so does not provide any physical registration of the *rate* of its movement.

Relativity, as already said, comprises a great deal more than a collection of logical and experimental proofs of the old, general fourth-dimensional theory of Time. But there seem to be only two points in its teaching which are of immediate concern to ourselves:

1. The Relativist recognizes the existence of a Time embracing Time, even though he may not realize that this is a *serial* conception.

2. It is part of Relativity theory that the tracks before and behind the position of any assumed Time-travelling observer possess, in all their cross-sections, all the observable characteristics of a three-dimensional world of matter.

## CHAPTER XIX

WE are now, I think, justified in accepting three propositions :

1. That the brain contains memory traces of our past, attended-to experiences.

There seems to be no escaping this conclusion. Concussion does not destroy merely the ability to give verbal or other expression to the memories involved. The memories themselves are in some way affected, for the patient's mind appears to himself to be completely blank so far as these memories are concerned. And, since the physiological evidence is that such traces must in any case be formed, and must be destructible, we have no grounds on which to seek for any other explanation of the facts.

2. That Time has length, divisible into years, days, minutes, etc.,—a length in which each instant lies between two neighbouring instants,—a length in which events are situated.

That is the standard conception. And its enunciation is equivalent to saying that Time is a fourth way in which length can be measured—a fourth dimension of Extension.

We are not, however, accepting Proposition 2 merely because it embodies the popular view. We do so because it follows logically from Proposition 1. For we have to recognize that a brain stimulation which is past, and a similar brain stimulation at a much later period, are, not one and the same event, but two events separated by intervening events. We might have imagined that separation

as being in some fourth-dimensional "memory train." But Proposition 1 rules out that idea. We start with the conception of memory as being merely the re-stimulation of an old brain trace. Hence we have to regard the separation of the two brain events as being in Time.\*

Incidentally this means that our Time length is not unoccupied; it contains physical configurations. This argument might have been useful, were it not that the reader is, I take it, already satisfied by the argument in Chapter XVII. that the conception of Time as having length is utterly meaningless unless that length is regarded as occupied by such events. Moreover, if Time has length, the endurance of anything in Time must mean, as Wells pointed out, extension in that length.

The question as to whether each individual has his own private Time direction, or whether there is only one Time direction, common to all observers, is a question which will be immaterial to our argument; and the reader may accept whichever view he pleases.

3. That the observer observes cerebral events—or, if you prefer it, their psychical correlates—in succession.

The reader who wishes to dispute this proposition, or to assert its non-significance in the realm of our practical knowledge, must be prepared to maintain, whenever he suffers from gout, toothache, indigestion, rheumatism, or any other of the pains which punctuate our earthly histories, that the discomfort which he is actually enduring has no more real significance to him than has a similar pain which he remembers as having happened in the past—that

\* See also the criticism of Bergsonism in the third section of the present chapter.

he is feeling the two pains, past and present, equally. To avoid all possible misconception as to what this succession in experience implies, let us consider your physical cerebrum as a "world-line" (Fig. 2) extended in Time. We are not considering *motion* in Time, but only extension therein.

At A, B, and C the cerebrum is in a condition which means acute discomfort to the observer, C being that point, called "death," where bodily dissolution begins. It may be argued that the cerebral section at A is experiencing the discomfort at A, and that the cerebral section at B is experiencing

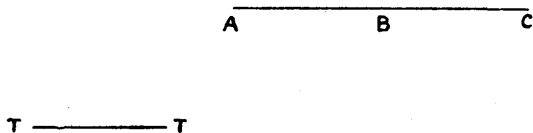

FIG. 2.

the discomfort at B, and so, of course, is not experiencing the discomfort at A or C. But the point is that *you*, whom we will assume to be experiencing the discomfort at B, *did* experience the discomfort at A, and may be looking forward with considerable misgiving to the experiencing of the discomfort at C. Why should the cerebral section at B be in a state of alarm about what is happening to the cerebral section at C? It is not going to experience that particular discomfort itself: it remains where it is. But you, the observer, know only too well that you are *not* going to continue observing the cerebral event at B. You know that you will presently be observing the cerebral event at C, and that, even though C represents the end of your little personal cinema show, no power of yours

can prevent its ultimate occupation of your screen of observation. Your field of observation must have moved, therefore, from A to B, and be moving from B towards C.\*

\*            \*            \*            \*            \*

We may note here that we need not trouble to debate the question as to whether the idea of Time as having length is an analytical device or the recognition of a "reality." Analytical devices are merely instruments for rendering manifest differences and relations which, without such assistance, would remain concealed. But unless these relations are already there, waiting to be brought to light, the analytical device can exhibit nothing new. It is true that such contrivances may describe phenomena in a language of their own,—as the mercury column in a thermometer indicates degrees of temperature in terms of divisions of height, or as the mathematician represents variables in terms of  $x$  and  $y$ ,—but that does not affect the question. Whatever the analytical device exhibits must have its corresponding characteristics in the underlying reality; and that is all that need concern the man of science.

However, lest the reader should suspect that he is being manœuvred into a position he did not intend to adopt, it might be as well to point out this: All the practical, everyday questions he asks himself regarding Time are questions *based* upon the assumptions that Time has length, that events are positioned along that length, and that he experiences these events in succession. The answers to those questions must, therefore, be given *in terms of those assumptions*.

\* The reader will find this argument elaborated at greater length when we come to make use of it in Part V.



It might, also, be advisable, at this point, to warn the reader against a conception which is in the nature of a trap. "Why," it may be asked, "do all these Time-dimensionalists, past and present, exhibit their physical 'world-lines' as extending *ahead* of that 'present moment' represented by AB in Fig. 1? Why should we not modify that diagram, and say that the world-lines are *growing* in Time, as shown in Fig. 3?"

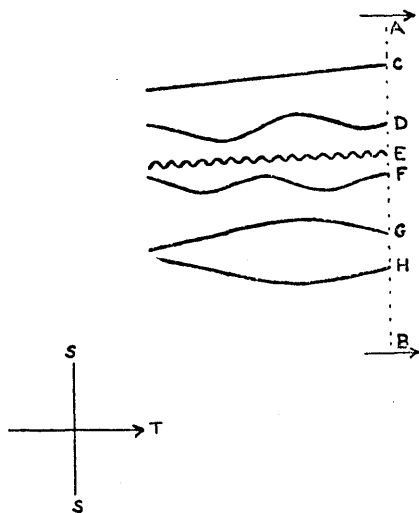

FIG. 3.

The answer is that such a conception offends against the scientific law of the Economy of Hypothesis. That law forbids us to introduce, when considering a problem, more hypotheses than are strictly needed to cover the facts. For an unnecessary hypothesis is an *unwarranted* hypothesis.

Consider how the law applies in the present case. Fig. 4 represents the facts to be considered before we introduce the clarifying conception of Time's length. It represents a world of Space in which particles are moving about.

In this diagram we have—

1. Physical objects, C, D, E, F, G, and H.
2. Only *one* kind of activity—the motions of these objects up and down in the dimension representing Space. But these motions may be of varying velocity—a characteristic which we find it very difficult to comprehend or define. In fact, we had to wait till Newton's day before we could exhibit such varying velocities as determined by laws.

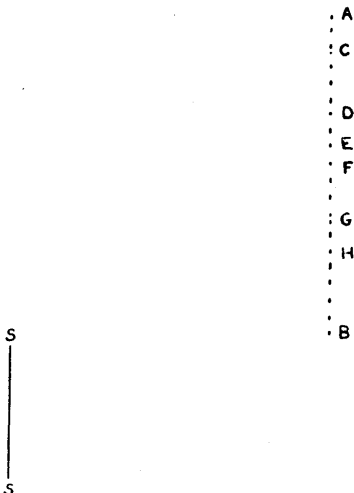

FIG. 4.

Now, introducing a Time dimension, we have, in Fig. 1 (the reader is advised to glance back at this)—

The physical objects, one dimension larger than in Fig. 4.

In comparison with this, we have, in Fig. 3—

The physical objects, also one dimension larger than in Fig. 4. But, in addition—*unnecessary addition*—we have it that these extended objects must be conceived as being perpetually added to by a process of *creation*. This is a very strange proposition, and one for which we have no evidence whatsoever.

Turning to the way in which motion is exhibited, we have, in Fig. 1—

Still no more than *one* kind of activity—the motion of AB in the Time dimension.

We have gained, however, this much: We have succeeded in *generalising* motion (a very important thing from the mathematical and philosophical point of view). We have got rid of all the varying, reciprocating motions of Fig. 4, and have substituted for these the single, simple, uniform motion of AB in the Time dimension.

In comparison with this, we have, in Fig. 3—

Activity in the Time dimension (as in Fig. 1); for the world-lines are being constructed by uniform growth in that dimension.

But we also still have activity in the Space dimension (as in Fig. 4); for the world-lines are being constructed by growth in that dimension as well as in the Time dimension.

Moreover, we still have the original complexity of motion of Fig. 4; for the growings in the Space dimension are of varying velocities.

Thus, while Fig. 1 involves the minimum of hypotheses necessary to cover the facts, and, incidentally, reduces motion to its simplest aspect, Fig. 3 introduces an additional, and so quite unnecessary, hypothesis—an hypothesis, moreover, which, instead of simplifying our idea of motion, adds further complexity thereto, and an hypothesis which is, in itself, of an extremely dubious character.

So our choice lies between Fig. 4 and Fig. 1, according as to whether we do or do not want to analyze the significance of Time.

The reader will, perhaps, forgive me if I conclude this chapter with a section addressed more particularly to students of Bergsonian philosophy.

\* \* \* \* \*

Fig. 3 seems to me to represent with absolute accuracy the conception of Time finally adopted by Professor Henri Bergson in his essay published the year following the appearance of Hinton's monograph. The date is of interest as showing that the fourth-dimensional theory of Time was well to the fore in those days.

Bergson begins by considering the supposed four dimensions of Extension,—three of Space and one of "duration,"—and argues that the last-named is spurious.

From this one is apt to assume, rightly or wrongly, that by "duration" is meant Time, and that Bergson is attempting an analysis of Fig. 4 without employing the device of a Time dimension.

The moments of "pure duration," he holds, are not external to one another, but are "superposed," presumably as a printer might superpose pictures.

Presently, however, it becomes clear that "pure duration" is not "Time."

"To sum up," he says, "every demand for explanation in regard to freedom comes back, without our suspecting it, to the following question: 'Can time be adequately represented by space?' To which we" (*i.e.*, Professor Bergson) "answer: 'Yes, if you are dealing with time flown; no, if you speak of time flowing.'"\*

And that, obviously, is what is represented in Fig. 3.

"Pure duration" thus seems to be identifiable with the man-in-the-street's "present" and Hinton's moving "narrow space and single moment"—the line AB in Fig. 3.

But Bergson sees that this acceptance of a Time dimension with moments which are external to one another is not enough. His "pure duration" also has its moments, and these are *not* external to one another, but superposed.

He leaves us, thus, to contemplate two sets of moments—those which are superposed, and those in the "past" part of a Time dimension.

Speaking entirely for myself, I should say that Bergson's superposed moments of "pure duration" are his acknowledgments of the existence of that Time embracing Time which insists on obtruding itself into every attempt at temporal analysis. His growing "past" takes Time to grow. But it would seem that Bergson, unwilling to recognize such a series of Times, and compelled by his earlier pages to grudge every inch of extension to any sort of Time whatsoever, has to take refuge in the "superposition" idea.

Professor H. Wildon Carr (*vide* p. 114 of "The Philosophy of Change") seems to exhibit Bergson's theory

\* "Time and Freewill," p. 221.

in a slightly different light, the element in Fig. 3 which grows as a train of past events being called "Memory." Remembering is, thus, a backward jumping of consciousness in a memory dimension. This theory, presumably, is what compels Bergson to devote so much time to a courageous, if rather forlorn, attack upon the accepted physiological view of memory. But Fig. 3 serves equally well to illustrate Wildon Carr's interpretation. We have merely to change the T in the dimension-indicator into an M standing for memory, and to label our moving line AB as DD standing for Bergson's "pure duration."

In either case the diagram stands condemned for the same reason as before: it introduces the totally unnecessary hypothesis of continual creation out of nothing, in addition to extension in a fourth dimension; and this at the cost of still further increasing, instead of simplifying, the complex character of variable motion.

Bergson's attitude as regards future events is emphatic. As in Fig. 3, they simply do not exist in any shape or form whatsoever. His argument for freewill is based upon that.

## PART V

### CHAPTER XX

A "SERIES" is a collection of individually distinguishable items arranged, or considered as arranged, in a sequence determined by some sort of ascertainable law. The members of the series,—the individually distinguishable items,—are called its "*Terms.*"

The nature of the terms, when these are considered apart from their standings as members of the series, is of small consequence to the mathematician. The terms may be, let us say, peas in a pod, or the oscillations of a pendulum, or ridges and furrows in ploughland, or the stresses along a cantilever girder—it is all one to him. His interest is concentrated on the *relation* between the terms—the relation which links each term to the next and makes manifest the law that binds the whole into an ordered extension.

This characteristic relation between the terms may or may not affect the values of the terms themselves. Thus the essential significance of a pea is not, that I know, greatly affected by the fact that it lies in a row of similar peas. But each swing of the pendulum owes the extent of its movement to the previous swing. And the stresses at any place in the cantilever girder, due to an applied load at the girder end, depend for their magnitudes upon the particular relation connecting the series of stresses along the structure. (For instance, in

the simple beam shape, the values of the forces acting upon the uprights and diagonals constitute series of equal terms; but the values of the forces acting upon the longitudinal members constitute series in arithmetical progression.)

In the *first* term of a series, the relation which links the terms is absent on one side; and this lop-sidedness may have a very practical significance. Thus the first swing of the pendulum has no previous swing to determine it: it must be started by an external agency. The first furrow in a ploughed stretch differs in section from all the others. And the forces acting on the end members of our cantilever girder are balanced at the outer ends, not by pushes and pulls in similar members, as elsewhere in the series, but by the externally applied end-load.

Now, we have seen that if Time passes or grows or accumulates or expends itself or does anything whatsoever except stand rigid and changeless before a Time-fixed observer, there must be another Time which times that activity of, or along, the first Time, and another Time which times that second Time, and so on in an apparent series to infinity. And we might suppose that every philosopher who found himself face to face with this conspicuous, unrelenting vista of Times behind Times would proceed, without a moment's delay, to an exhaustive and systematic examination of the character of the apparent series, in order to ascertain (*a*) what were the true serial elements in the case, and (*b*) whether the serialism were or were not the sort of thing that might prove of importance. For, of course, it might turn out to be an entirely negligible affair. But, to people who have devoted their lives to the search for a simple explanation of the universe,

the idea that one of their approximate fundamentals—next door, indeed, to the sought-for nothingness—might prove to be of a serial character would be bound to appear a supposition to be avoided at almost any cost. Quite rightly, they would pause, and look round for some shorter path. Yet to a halt of that kind one is obliged to set a limit. To stand, for twenty-two centuries, staring at a perfectly open road is not necessarily at variance with the recognized traditions of philosophical procedure. But it would be a pity to risk having this estimable circumspection mistaken for commonplace somnolence.



## CHAPTER XXI

WHETHER we embark upon the analysis of a serial time because of the logical compulsion, or whether we do so from motives of curiosity as to what sort of a country such an avenue would be likely to reveal, we must realize that, if we discover anything which is not already manifest in the ordinary, accepted first stage of the series, that thing will be something outside the purview of any philosophy which has been developed upon the basis of a uni-dimensional Time. That is to say, it will be something entirely strange to our present views of existence. We shall have, therefore, no right to halt and haver merely because we encounter novelty—novelty is what we are expecting to find. We must bear in mind, moreover, that serialism in Time is almost bound to signify serialism in other matters. In actual fact (the reader had best be warned of the worst) we shall find that it involves a *serial observer*.

In these circumstances the strictly proper course will be for us to get the analysis finished first,—regardless of whether what is exhibited appears as probable or the reverse, so long as it follows logically from our premises,—and *then* proceed to ascertain whether the results do or do not assimilate with the general body of our knowledge. And, as it happens, this is one of those cases where the adoption of a correct method is imperative; for it is not until the analysis is finished that the new conceptions begin to assume any sort of complete significance.

The reader, then, is advised to put all thoughts

of meanings and implications entirely out of his mind until we come to the next chapter, and to regard the present analysis as a simple mental exercise of no more actual import than a cross-word puzzle. So that all he will need to do for the moment is to satisfy himself that the three laws recited at the conclusion of this chapter are laws which have been properly deduced from our premises, and that they represent quite truly the relations between the terms of our series.

\* \* \* \* \*

“From the windows of our railway carriage,” says Professor Eddington, “we see a cow glide past at fifty miles an hour, and remark that the creature is enjoying a rest.”

This is an illustration which pleases in more ways than one; and I regret to have to interrupt the reader’s contemplation thereof in order to direct his attention to a picture painted in less enticing colours. But we have to get on.

We are still, then, seated in the same carriage; but this is now standing at a railway station. Looking from the windows on the side remote from the platform, we perceive another train at rest upon the rails. As we watch it a whistle blows, and we become aware that our train is beginning to pull out. Faster and faster it goes; the windows of the opposite train are running swiftly across the field of view; but . . . a doubt arises . . . we miss the accustomed vibration of our vehicle. We glance towards the platform windows, and discover, with something of a shock, that our carriage is still stationary. It is the other train which is moving.

Now, in the first of these two cases attention is fixed upon the visual phenomenon of the cow; this

phenomenon moves across the "field of presentation," and attention follows it. We judge that attention is directed to a point in the field of presentation corresponding to something which is fixed in external Space; and that, while attention is thus fixed, the field of presentation, *and the observer, move.*

In the other instance, again, the visual phenomenon of a window pertaining to the opposite train moves across the field of presentation, and attention follows that phenomenon. Again we judge that attention is fixed and that the field—*with the observer*—is moving; but afterwards, in the light of other evidence, we reverse that judgment and say that the field and observer must have been fixed, and that attention must have moved.

In each case, then, the judgment may differ; but in each case the direct psychological *experience* is of the same general character. The phenomenon observed, whether this be the cow or the window of the opposite train, moves across the field of presentation—followed by the focus of attention—until it disappears at the edge of the field. *And in each case the field of presentation remains fixed with regard to the observer.*

Such a field of presentation, fixed with regard to the observer, and in which *conscious observation, condensed to the shifting focus called "attention,"* is assumed to be taking place, is bound to be the starting-point of our analysis. (All readings of instruments are perceived as appearances within that field.) It must be remembered, however, that the field contains phenomena other than visual; it embraces, in fact, every species of mental phenomenon which, whether attended-to or not, is being presented for observation. It represents the

observer's *outlook on Space*. And, on our theory, it occupies the same spacial position as does that portion of the observer's cerebrum which is in the state of apparent activity associated with the production of *observable* psychical phenomena.

We shall represent this spacial position of field and cerebrum by CD in Fig. 5, the up-and-down dimension of the paper being regarded as Space. Temporal measurements are not yet shown.

Since the contents of CD are to be considered as in a state of apparent activity, they must be imagined as apparently moving up and down in

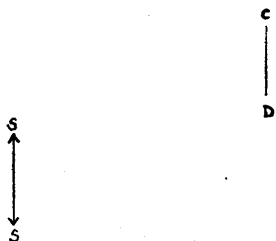

FIG. 5.

the dimension representing Space. Moreover, the length of CD is uncertain; for larger or smaller portions of the cerebrum may be active at different instants. The diagram is to be looked upon, in fact, not only as a model, but as a *working* model. We indicate this by fitting two little arrowheads to the dimension-indicator at the bottom of the diagram, showing that apparent motion in Space is supposed to be taking place.

(It must be remembered that, according to the more commonly accepted view of Space, CD itself may be moving as a whole in the Space dimension.)

Fig. 5 is our starting-point. It does not repre-

sent a "term" in the series; for Time is not being indicated therein at all.

To the observer whose field of presentation occupies the spacial position CD, events are presented in succession. To him Time is apparent as an insistent characteristic of existence—a characteristic which, though real enough to be of immense personal importance, cannot be defined in terms of the three-dimensional limits of his spacial outlook. Phenomena in his field seem to move about, alter, and vanish. And these changes appear to "take Time." He endeavours to identify this "Time taken" with a bit of Space moved over by some indicator such as a clock-hand; but fails because he cannot rid himself of the knowledge that the movement of the clock-hand is not measurable in terms of the clock-face alone. The hand "takes Time" over its movement: it may traverse the clock-face quickly or slowly. Stopping the clock does not prevent other movements from "taking Time." He is aware of a growing store of memories; but is certain that this growth is also a process which "takes Time." Even when he sits in the dark and thinks, he is aware that such thinking is "taking Time." And when he recovers from an anæsthetic, he has evidence that Time has "elapsed."

He realizes that this "Time" which is "taken" is a measurable thing; that the measurement involved is of the simple, one-way kind called "extension"; and that, in this extension, the phenomena he observes persist for longer or shorter lengths. And, since we are in entire agreement with him, we will proceed to introduce this dimension of extension into our diagram as the side-to-side dimension of the paper.

The total process may be more easily followed if we divide it into two half-steps. The first of these consists merely in showing the physical elements in the cerebrum CD as having extension (*i.e.*, *endurance*) in Time. We begin by taking an instantaneous photograph of Fig. 5. To avoid trouble with the Relativitists, we shall assume that we are standing side by side with the proprietor of CD. We may, thus, consider the positions which the apparently moving elements exhibit in that photograph as their position at that particular instant of Time which both we and the owner of the cerebrum in question regard as the "present" instant. This photograph is shown as CD in Fig. 6 (a), or as C'D' in Fig. 6 (b). We show the "past" and "future" states of the apparently moving elements of Fig. 5 as occupying fixed positions to, respectively, the left and right of CD (or C'D') in a Time dimension.

These "past," "present," and "future" states will together give us a band of wavy lines enduring (extending) in Time. A vertical (spacial) cross-section taken anywhere in this band will indicate what psychoneural phenomena would be observed at that instant of Time—if the field of presentation were there.

But although "past" and "future" states of the cerebral elements are shown as entities occupying fixed positions in the Time dimension, it is questionable whether we are treating the field of presentation in the same way. The fact that CD in Fig. 6 (a) or C'D' in Fig. 6 (b) is a snapshot of the moving elements of Fig. 5 at an instant of Time which both we and the owner of the cerebral elements photographed regard as the "present" instant, seems to suggest that CD (or C'D') is the

only field of presentation in the whole extension. We note this *en passant*, and, while waiting for further light on the subject, proceed to consider the essential difference between Figs. 6 (a) and 6 (b).

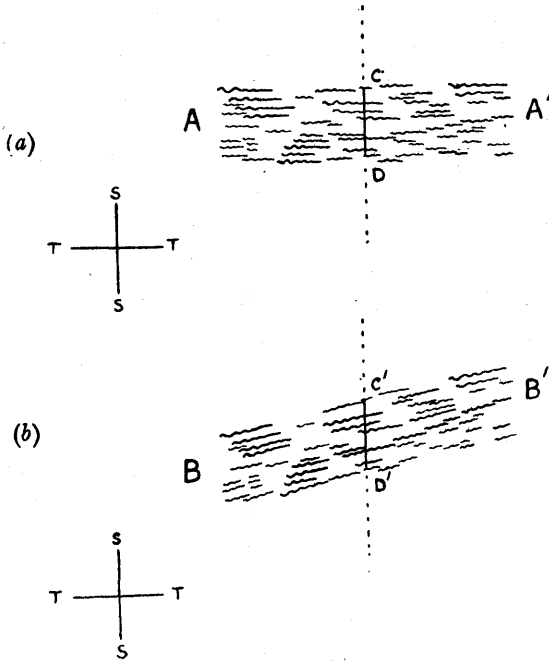

FIG. 6.

It will be seen that whereas, in Fig. 6 (a), the band of lines is shown running straight along the Time dimension, the trend in Fig. 6 (b) is slightly aslant. This is because AA' represents the only possible extension according to the views of those who, like the Relativitists, hold that distinctions between Space dimensions and Time dimensions are merely artificial distinctions drawn by individual

observers, each of whom regards the direction in which his body lines extend as being the Time dimension. According to that theory, our statement that we are regarding the vertical dimension of the paper as Space, and the horizontal dimension as Time, is simply acquiescence in the opinion of the owner of the cerebrum shown in Fig. 5, and it commits us to agreement with his complementary view of his own Time endurance as something extending straight along the Time dimension. But  $BB'$  represents one of the many slanting extensions regarded as possible by those who maintain that the Time direction is the same for everybody, and that it has nothing to do with the direction of any particular observer's body-lines.

The "present moment" in Time is indicated in each case by the dotted prolongation of the line representing the instantaneous photograph  $CD$  (or  $C'D'$ ).

We have now accomplished the first of our two half-steps, and it will be seen that the result is to leave us with a very incomplete representation of the state of affairs which we started to analyze—the state exhibited in Fig. 5. The elements in that diagram were considered as apparently *moving* up and down in the Space dimension, such motion being apparent both to the owner of the pictured cerebrum and to ourselves. The diagram was to be regarded as a working model, exhibiting its states in *succession*. But there is no evidence of any appearance of motion to any observer in Figs. 6 (a) and 6 (b). The lines which show the elements of Fig. 5 in their Time extension—the bands  $AA'$  or  $BB'$ —are considered as being stationary in all dimensions. (For that reason we have had to remove the arrow-heads from the little dimension-indicator.)



And the cerebral states represented by the various cross-sections of those bands are not being presented to any observer in succession. Either they are all being presented together, or else one only is being presented—the state at the “present” instant, CD (or C'D').

The second of our two half-steps consists in the reintroduction of these missing phenomena of motion. We do this in the obvious and, indeed, only possible way—the way to which the reader is now accustomed. We simply add an arrow-head to the T in the dimension-indicator, in order to show that CD (or C'D') is—as we had all along suspected—the only field of presentation in the diagram, and that this field is travelling along the Time dimension in the direction indicated by that arrow. We do this in Figs. 7 (a) and 7 (b).

And we do one thing more. We place the numeral 1 after the T in the dimension-indicator. The reason for this will be apparent in a moment.

The first stage of our analysis is now complete, and it brings us to a merely revised edition of our starting-point. Our diagram is again a working model, and it no longer contradicts the statements we made regarding Fig. 5. The line CD (or C'D') is still, as we had originally stated, a field of presentation. Events are being presented in succession within that field. And the intersection points between that travelling field and the wavy lines are moving up and down within the field, giving the appearance of moving elements.

As the field of presentation moves over the extended substratum, some of the phenomena presented in the field will appear as moving in relation to other phenomena in the field. For attention, focussed upon the apparently moving phenomenon,

has a fringe which covers enough of the immediately adjacent, comparatively non-moving phenomena to enable the difference to be perceived.

There is no evidence here, of course, that such movements of attention are anything more than

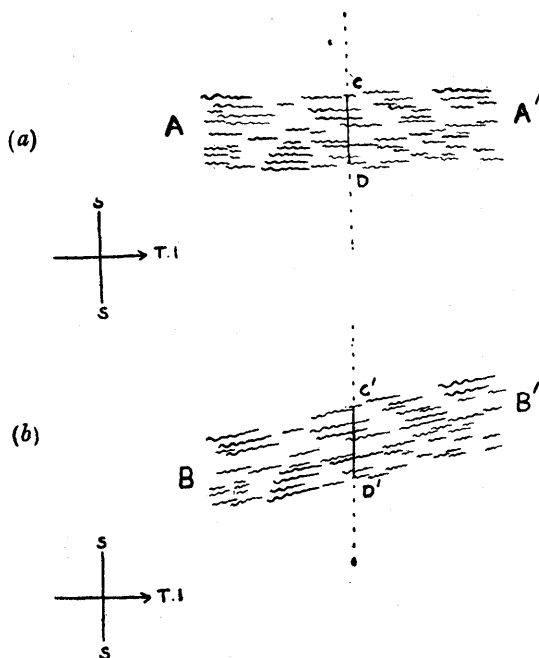

FIG. 7.

conditioned, non-voluntary activities in the field of a non-intervening observer.

The result of this first stage leaves us, however, still dissatisfied. Analyzing what was involved in our premises, we have arrived at conclusions which, so far as they go, are logically unescapable. The trouble is that they do not go far enough.

To begin with, we find ourselves confronted with a new object for consideration: to wit, a Time-travelling field of presentation.

Now, we cannot separate that travelling field of presentation from an observer to whom its contents are being presented—contents provided by the cerebral elements in the substratum travelled over. Hence, CD (or C'D') must be regarded as the place where this observer (a Time-travelling observer) intersects with AA' (or BB'). The field in question is, of course, our original field, and the observer thereof is our original, conscious observer. And this observer must be a definite entity; for no mere abstraction can *travel* in, so to say, its own unsupported right.

It is to be noted, however, that there is nothing here which need alarm the materialist. It is abundantly clear that, when this observer, with his field, reaches the terminus of the cerebral substratum, he will find that the observable phenomena have come to an end. Nor is there anything to show that he has the smallest capacity for interference with the purely mechanical sequence of the cerebral states which he observes.

We are bound to regard this observer as three-dimensional. And, to avoid any possible confusion, we had better set forth exactly what that statement implies.

A Time dimension, for any observer, is a dimension in which *all* the events which he experiences appear to him to follow one another in a definite sequence—a dimension in which he (or his attention) does not move backwards so as to upset that order of successive experience. Those dimensions in which his attention can move to and fro appear to him, therefore, to be at right angles

to that Time dimension. Whatever dimension, then, in our diagrams, actually determines, for the observer moving therein, that order of successive experience, is that observer's true Time dimension.

To the observer we are here considering, the dimension which thus determines the order of his successive experiences is the dimension moved over by the field. The to-and-fro movements of his attention are, therefore, confined to the three spacial dimensions at right angles to that Time. So he is an entity whose *capacity for such observation* is three-dimensional. And that is what we mean by calling him a three-dimensional *observer*.

Whether he has, or has not, in other capacities, extensions in other dimensions is immaterial to the arguments in this chapter. As an *observer* he is three-dimensional.

Now, our first stage, again, has left us with a new Time problem to consider. For the observing entity, with its field CD (or C'D'), is travelling neither so slowly as to be stationary, nor so rapidly as to be in all places at once; and every condition between those two extremes must be describable in terms of Time taken per distance traversed. But the distance traversed is along our first-considered time dimension; so the time which is taken must be a Time which is not shown anywhere in the diagram. Just as our first-considered Time is not indicated anywhere in Fig. 5. Hence we mark the T in Figs. 7 (a) and 7 (b) as T<sub>1</sub>, to show that it is not the ultimate Time which times the movements, real or apparent, in those diagrams. That ultimate Time we may call Time 2.

\* \* \* \* \*

In order to simplify our next diagrams, we shall now draw the bands AA' or BB' (it will not here matter which) as they would appear to an eye set level with the page and looking up that page from bottom to top. Seen thus, either band would appear as a single line; and this line is represented by GH in Fig. 8. The field CD (or C'D')—the place where our travelling observing entity intersects—is represented by the travelling point O. And each fixed point between G and H represents a single cerebral state, a spacial cross-section of either of the bands AA' or BB'.

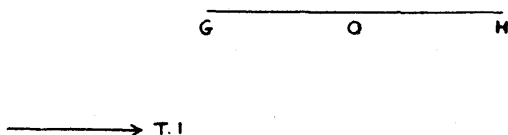

FIG. 8.

The Space dimension shown in Figs. 7 (a) and 7 (b) is here sticking out at right angles to the page. We shall have no room in the picture for other Space dimensions; but we may remember that they are supposed to be intersecting the diagram.

The view of affairs represented in Fig. 8 may be regarded as the first "term" of our series. Time is exhibited and analyzed therein, and it is shown that it is not ultimate Time.

Our business is now to exhibit the Time taken by the movement of O from left to right of Fig 8 in exactly the same fashion as we exhibited the Time taken over the Space movements of the elements in Fig. 5.

The new dimension of Time will have to be at

right angles to GH, just as our original dimension of Time had to be made at right angles to CD in Fig. 5. We shall, as already said, call this new dimension Time 2. In relation to this Time 2, Time 1 is, theoretically, akin to any of the three "ordinary" dimensions of Space. Instead of a four-dimensional world in which the fourth dimension is Time, we have now a five-dimensional world in which the fifth dimension plays that insecure rôle.

In this Time 2 all the entities in GH, including the travelling entity at O, have endurance. That is to say, they remain in existence while you watch O travelling. These endurances will have to be shown as extensions in the Time 2 dimension.

We begin, as before, by taking our instantaneous photograph of our working model. This photograph is taken at what is, to us, the "present moment" of ultimate Time,—the Time which times the movement of O along GH,—that is to say, Time 2. It represents the condition of Fig. 8 at that "present moment." We exhibit this photograph as GH in Fig. 9, the line  $pp'$  indicating the "present moment" in question.

Next, we have to show the "past" and "future" (in this Time 2 dimension) conditions of the fixed cerebral states represented by the fixed points in GH as, respectively, below and above their "present" condition in GH. Since these states do not change their position either in Space or in Time 1, their endurances in Time 2 must be shown as extensions *straight* up Time 2. They thus become, in Fig. 9, vertical lines extending up and down the page with no limit either way that we are, as yet, able to assign. But we need treat only a few selected points in this fashion.

We have now another definite entity to consider

—the three-dimensional observing entity which intersects at the three-dimensional field  $O$ . In the "present" condition of Fig. 8 ( $GH$  in Fig. 9) the point of this intersection is at the middle of the line. Since, however, this point is, in Fig. 8, travelling along Time 1, its positions in the "past" conditions of that diagram must be shown more

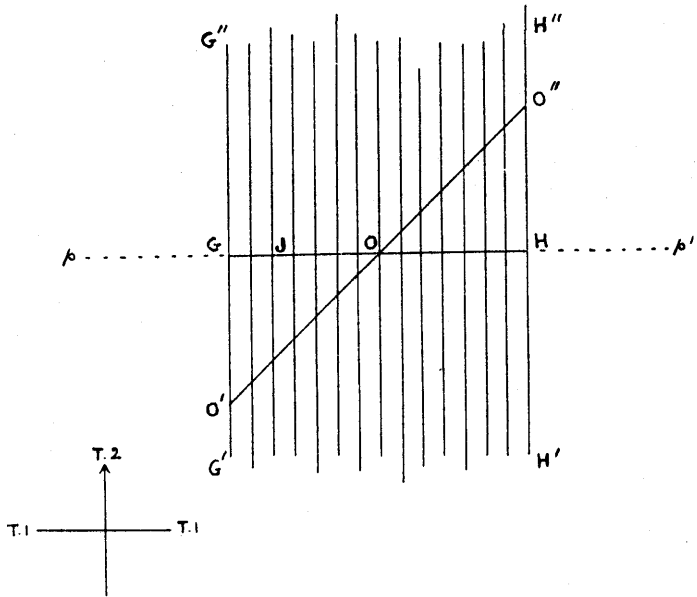

FIG. 9.

towards the  $G'G''$  side of Fig. 9, and its positions in the "future" conditions must be shown more towards the  $H'H''$  side. Linking up these various points of intersection, we get a diagonal line like  $O'O''$ . This line will represent the endurance (temporal extension) of the definite intersecting entity.

Here we have to ask ourselves again the same

question that we asked in stage 1. We have shown the "past" and "future" states of all the definite entities in our working model (Fig. 8)—including the intersecting entity at O—as extensions of those entities, occupying fixed positions in the "past" and "future" parts of the Time 2 dimension. But have we treated our original three-dimensional *field of presentation* in that fashion? Our answer here is bound to be the same as before, and for the same reason. Though everything else in our Time maps were fixed, this field of presentation O would have to be moving. Otherwise the diagrams would not be working models, and would not represent that working model state of affairs which we set out to analyze. The cerebral states would not be being presented to any observer in succession. Either they would all be being presented together, or else one only—the state at the fixed O—would fall within that category. This three-dimensional field of presentation O must, therefore, always be regarded as travelling in such a fashion as to come upon the cerebral states one after another.

But before we consider further the nature of this motion, let us see whether we cannot ascertain a little more about the character of our observing entity O'O".

O has represented, from the outset, the three-dimensional field where *conscious* observation is taking place. It is clear, then, that, at the point O in our definite, enduring entity O'O", that entity is a *conscious* observer—our original, three-dimensional, conscious observer. What is it elsewhere? We might say, "an unconscious observer," but that is a dubious expression best avoided. A better name is unconscious "*reagent*," which would mean here, simply, an entity which reacts to, or is



modified in accordance with, the cerebral states (the vertical lines of Fig. 9) which it intersects. This name does not suggest observation in any sense beyond that in which an instrument observes. How such a "reagent" can become conscious at the field of presentation O is a matter which we shall be able to understand when we have completed the analysis. For the moment all that we know is that the reagent must be considered, on account of our original definition of O, as conscious at that point.

Now, O has to be regarded as travelling, and as travelling in Time 1. Since, while so doing, it must remain in O'O", it must be considered as travelling up that diagonal; that is to say, as travelling up Time 2. Which means that, for our *ultimate* observer to observe the contents of the instants of Time 1 in succession it is necessary that he shall observe the contents of the instants of Time 2 in succession. He must have a field of presentation travelling up whatever is ultimate Time—in this case, Time 2.

By analogy with stage 1 we should expect that the *whole* of GH in Fig. 9 (the instantaneous photograph of Fig. 8 at a moment of Time 2 which appears to us as "present") would turn out to be this field of presentation travelling up Time 2—a field the existence of which could not become evident until Fig. 8 had been expanded in Time 2. Just as, in stage 1, the existence of a Time-travelling field CD (or C'D') within the apparently active Fig. 5 could not become evident until Fig. 5 had been expanded in Time 1.

It will be remembered, however, that the first term of a series may differ in some respects from all the remainder. Consequently it might be wiser not to trust to analogy here, but to continue to

establish the characteristics of our second term by direct analysis of what is involved in the fact of succession in experience.

O, then, is travelling up  $O'O''$ . *But the only thing which marks off O as a definite point in  $O'O''$  is the line GH.* This line, therefore, must be travelling up Time 2. GH, however, represents the condition of Fig. 8 at what we are considering to be the "present moment" in Time 2. Hence this "present moment" in Time 2 is travelling up Time 2.

It is advisable to remember here that, just as Time 2 is true Time in this stage, so is the Time 2 travelling "present moment" the true travelling "present moment." Our old, Time 1, travelling "present moment" has become merely an intersection point between the true travelling "present moment" in Time 2 and a fixed diagonal in the diagram. It does not exist in its own right, but is determined by the Time 2 "present moment." The point O is *determined by  $pp'$* . To put it in scientific language, our Times are arranged in *series*, not in *parallel*.

Now, the points in  $O'O''$  are being consciously and *successively* observed from  $O'$  to  $O''$  by whatever is the ultimate observer. And we have just seen that the *only* thing which determines the order of succession in which these points are being observed is the travelling "present moment" in Time 2. So the *ultimate* observer of the changing point in  $O'O''$  is an observer for whom Time 2 plays the part of the real and only Time. It does not matter what he thinks about Time, or where he supposes it to extend. Time 2 is the Time which determines the sequence of his experiences. And Time 1 is at right angles to what is, for him, the

real and only determinative Time. Time 1 is, therefore, in relation to him, akin to a dimension of "ordinary" Space. In other words, just as, in stage 1, the ultimate conscious observer exhibited himself as a three-dimensional being in a three-dimensional world, so, in the more elaborate view afforded by stage 2, the ultimate conscious observer exhibits himself as the four-dimensional observer in the four-dimensional world marked off by  $pp'$ . This four-dimensional observer must have a four-dimensional field of presentation lying in, and travelling with,  $pp'$ .

But the discovery of new elements in our growing diagram does not entitle us to repudiate any previous supposition upon which that diagram has been erected. The argument for the existence of this field of presentation number 2 is *based* upon the hypothesis that there is a point O travelling in  $O'O''$ . And we may not now deny that  $O'O''$  is, at O, a conscious, three-dimensional observer. For it is only because we acknowledge, in stage 1, the presence of such a conscious, three-dimensional observer at that point in GH that we were enabled, later, to insert the line  $O'O''$  in the diagram. And so it goes from the beginning of the analysis. Nothing that has been previously ascertained and identified may be ignored later on. All that we may do is to discover new elements as our diagram grows more elaborate.

Hence the three-dimensional field of presentation of our stage 1 observer turns out to be an element in the four-dimensional field of our stage 2 observer. And the discovery that there is a stage 2 four-dimensional observer—observer 2, who is the ultimate conscious observer we are seeking—means that our "reagent" is, at its conscious three-dimen-

sional section O, an element in the field of observer 2.

Then, again, observer 1's attention (which is merely a name for concentrated observation, whether externally determined or otherwise) was regarded as focussed upon some particular phenomenon in field 1. The attention of our ultimate observer must also be regarded as focussed about that same phenomenon. But the focus of observer 1, who is three-dimensional, must be itself three-dimensional. And the focus of observer 2 must, similarly, be four-dimensional. Hence the three-dimensional focus of observer 1 must be surrounded by the four-dimensional focus of observer 2.

How far, now, are we to say that field 2 extends along  $pp'$ ? From G to H, replies analogy. But we are not trusting to analogy; and so I must ask the reader to follow me to the same conclusion by a rather longer route.

A field of presentation is delimited by certain cerebral states of observable character placed at what is to the observer at right angles to Time. In GH there is, we know, one such observable state—the state at O. But for GH to be a field of presentation from end to end, all the other cerebral states therein should be of an observable character.

Quite so. And that is precisely what they are. We extended them originally in Figs. 6 (a) and 6 (b) as "past" and "future" states of the cerebrum of Fig. 5—states which were all of an observable character.

Yes, but did not that imply that they were observable only to the conscious observer whose focus of attention was following field 1 in Figs. 7 (a) and 7 (b), and who, therefore, would experience those cerebral states one after another?

Again, quite so; but our now elaborated view of those diagrams has shown us that it was really observer 2 who was the ultimate conscious observer of the successive cerebral states in the bands AA' or BB', and whose focus, surrounding the focus of observer 1, was following field 1. So observer 2, following in this way the focus of observer 1, has already consciously observed the cerebral states (vertical lines) to the left of O in Fig. 9, and is going to observe similarly those to the right. All those states must therefore be, to him, of an observable character. And they lie in what is to him at right angles to Time. Hence, GH, from end to end, lies within the four-dimensional field of presentation. That its observer's attention happens to be following, for some reason, one particular point in that field—a point in O—does not affect the matter: a field of presentation is not limited to the focus of attention (*vide* Part I.).

Yes, but was not the cross-section of the diagonal reagent in the substratum of field 2 an intermediary observer in whose absence that substratum would not have been consciously observed by observer 2?

No, our ultimate observer is a four-dimensional observer with a four-dimensional focus of attention covering slightly four-dimensional bits of the substratum. But observer 1 is only a three-dimensional observer, reacting only to three-dimensional aspects. In his observational capacity he is not, to observer 2, a concrete entity at all. He is akin to a plane without thickness in a world of solids—observable only on condition that the solids are being observed. And his observations (modifications in accordance with the local three-dimensional character of the substratum) could not have been even observable

to observer 2 except as part and parcel of dimensionally larger areas observed.

So GH is, like CD (or C'D') in Figs. 7 (a) or 7 (b), a field of presentation. And, like those stage 1 fields, it stretches, athwart the Time dimension, from edge to edge of the cerebral substratum. Since this characteristic holds good in two terms of the series, we may regard it as a repetitive relation which will appear in every term.

We conclude stage 2, then, by fitting an arrow-head to Time 2 in the dimension-indicator of Fig. 9, in order to show that GH is a field of presentation moving up Time 2. The motion of field 1 along Time 1 is now recovered. For, as GH moves up the diagram, the point O, where GH intersects with O'O'', moves along GH towards H, thus coming upon the cerebral states one after another in succession from left to right.

Our diagram—which represents the second term of the series—is once again a working model. And it does not contradict the information previously provided by Fig. 8. In that figure, O was a point of intersection travelling along GH. Our more elaborate diagram confirms that statement, and merely supplies the additional information that the *travelling* of the intersection point is due to the Time-2-travelling of the GH which is intersected; that GH proving to be a field of presentation concealed in the over-compressed view afforded by Fig. 8. We still have at O our original three-dimensional observer moving along Time 1, but he proves to be merely a section—a conscious section—of his own temporal extension above and below in the form of the diagonal reagent.

It is to be noted that our travelling field 2, GH,

must be, in its turn, a line where a definite entity, observer 2, intersects with the plane figure  $G'G''H''H'$ . Also that, since the area around O—where this observer 2 is consciously observing—travels from end to end of GH, that observer must, everywhere throughout GH, be capable of conscious observation. Also that ultimate Time—the Time which times the movement of GH up the plane, and of O along GH—is not Time 2, but *Time 3*.

\*            \*            \*            \*            \*

We may, conveniently, carry the analysis one stage further; but we need not trouble to repeat the arguments.

We shall discover, of course, that the Time and the field and the observer which, in stage 2, we considered as being ultimate, were not ultimate at all; and we shall come upon a larger-dimensioned lot of ultimates which, in their turn, will only retain that status until the next stage is reached. And so on to infinity.

In Fig. 10 we exhibit three dimensions of Time as the three dimensions of a solid figure seen in perspective. We have to draw imaginary boundaries to this figure in order to make the perspective clear; but these edges have, properly, no position that we can, as yet, indicate, except where they mark off the beginning and the end of the extension of the cerebral substratum in Time 1. The block has sides, but, as yet, no other boundaries.

Time 3 is shown as the vertical dimension of the block. In relation to this Time the dimensions we call Time 1, and Time 2, are akin to dimensions of Space.

The middle horizontal plane-section of this block-

figure, the plane  $G'G''H''H'$ , is our instantaneous photograph of Fig. 9, shown in perspective. The endurences, in the new dimension of Time, of the cerebral states represented by the Time 2 extended lines in Fig. 9 should be shown by extending these lines in the Time 3 dimension so that they form vertical planes arranged like pieces of toast in a rack. But to

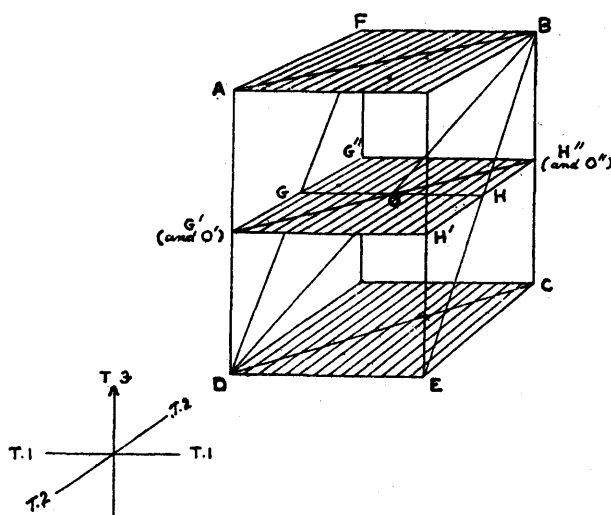

FIG. 10.

fill these in would overcrowd the diagram. Our first reagent,  $O'O''$ , will endure (extend) in Time 3 as a plane dividing the block diagonally; that is to say, the plane ABCD.

In the "present" condition of Fig. 9 (shown in the middle of the block), the field of presentation GH—which, be it remembered, must be marked out by the intersection of some definite observing entity with the plane of the figure—is at the middle of the plane. In the "past" condition of Fig. 9 (the plane at the



bottom of the block) this field—this line of intersection—is at DE. In the “future” condition of Fig. 9 (at the top of the block) this field is at FB. The definite intersecting entity, reagent number 2, lies, therefore, along the sloping plane DFBE, which plane represents its endurance.

The intersection of this plane with the plane ABCD is the line DB. The new travelling field of presentation (field 3) is the plane G'G''H''H'. As this field 3 plane travels up the block, its line of intersection with the sloping plane DFBE (the line GH) moves over the travelling field 3 plane towards G''H''. That is to say, field 2 moves along Time 2. The point O (where the three planes ABCD, DFBE, and G'G''H''H' intersect) moves, meanwhile, along the travelling line GH towards H. That is to say, field 1 moves along Time 1.\*

\*                    \*                    \*                    \*                    \*

The analysis will continue, evidently, in the same fashion to infinity. There we shall have a single multidimensional field of presentation in absolute motion, travelling over a fixed substratum of objective elements extended in all the dimensions of Time. The motion of this ultimate field causes the motion of an infinite number of places of intersection between that field and the fixed elements, these places of intersection constituting fewer-dimensional fields of presentation. At infinity,

\* It will be remembered that the figure is a diagrammatic representation of *serial* relations, and that one cannot, in considering movements within the block, overlook the system on which that block has been constructed. One cannot, for example, consider the point O as moving up DB, without, at the same time, recognizing the conditions of that movement—viz., that field 3 is travelling in Time 3, and field 2 in Time 2.

again, we shall have a Time which serves to time all movements of or in the various fields of presentation. This time will be "*Absolute Time*," with an absolute past, present, and future. The present moment of this absolute Time must contain all the moments, "past," "present," and "future," of all the subordinate dimensions of Time.

It will be noticed that we can never show the path which O *really* follows. In Fig. 9 this path appears as O'O", but in Fig. 10 it appears as DB. We have to show it differently with each introduction of another dimension of Time. But it will be seen that, to the observer of each specific moving field in the ultimate, completed diagram, O's path will appear to lie *within his field*. (For example, to the observer of the field GH in Fig. 10, O appears as moving from G to H.)

The nature of the series is now beginning to become apparent. It is akin to the "Chinese boxes" type—the type where every term is contained in a similar but larger (in this case *dimensionally* larger) term.

Its laws may easily be ascertained. As the first we have—

1. *Every Time-travelling field of presentation is contained within a field one dimension larger, travelling in another dimension of Time, the larger field covering events which are "past" and "future," as well as "present," to the smaller field.*

The second law brings in the serial observer. (This entity is not, of course, the same thing as a series of independently existing observers.)

We have seen that the contents of the instants of Time 1 can only be presented to the ultimate observer in succession on condition that the contents

of the instants of Time 2 are being likewise successively presented, and so with the contents of the instants of all the other Times in the series. This ultimate observer is, therefore, the observer of the field of presentation travelling up the dimension of Time at the infinity end of the series. As the observer of that field, he is the observer of all the lesser and contained travelling fields.

Again, O has been, from the beginning of the analysis, the place where *conscious* observation is taking place. So, at whatever stage we may halt, our ultimate observer at that stage is observing consciously at O. In Fig. 9, for example, observer 2, GH (coinciding with the field GH) is, like observer 1, consciously observing at O. But the interesting thing is that no observer possesses this power of conscious observation in his own right; he owes it entirely to the conscious observer next above him in the series.

For the travelling conscious observer GH is the only thing which, by its intersection with the reagent O'O", distinguishes in O'O" the place O wherein that reagent is capable of *conscious* observation. Omit GH, and there is no O. Similarly, when we pass to Fig. 10, we see that the travelling field 3, G'G"H"H' coinciding with conscious observer 3, is the only thing which, by its intersection with reagent 2, DFBE, distinguishes in DFBE a line GH wherein that reagent is capable of consciously observing, as at O. Omit G'G"H"H' from the diagram, and GH, containing O, vanishes. And so it goes on throughout the series, to infinity. In short, leave out the higher conscious and successive observer, and the lower observer ceases to exist as either conscious or successive, though there still remains an unnecessary and unjustified diagonal

reagent, unconscious, and reacting to everything at once.

*Therefore, just as the phenomena presented for observation are all ultimately referable to the set of cerebral states with which we started at the "hither" end of the series, so all conscious observation, like all successive observation, is ultimately referable to the observer at the "far" end of the series; that is, to the observer at infinity.*

("Observer at infinity" does not mean an observer infinitely remote, in either Time or Space. "Infinity" here refers merely to the number of terms in the series. The observer in question is merely your ordinary everyday self, "here" and "now.")

So for our second law we have—

2. *The serialism of the fields of presentation involves the existence of a serial observer. In this respect every time-travelling field is the field apparent to a similarly travelling and similarly dimensioned conscious observer. Observation by any such observer is observation by all the conscious observers pertaining to the dimensionally larger fields, and is, ultimately, observation by a conscious observer at infinity.*

Hence, since "attention" is only a name for concentrated conscious observation, the attention of the observer pertaining to any field must be referable to the attentions of the observers pertaining to the dimensionally larger fields, and so to the observer at infinity. But the focus of attention (the area covered by observation of a given degree of concentration) must have, in each case, the same number of dimensions as have the observer and his field. In field 1 it is three-dimensional; in field 2 it is four-dimensional; and so on.

Consequently we have, as our third law—

3. *The focus of attention in any field has the same number of dimensions as has that field, and is a dimensional centre of the foci of attention in all the higher fields, up to and including attention in the field at infinity.*

And now let us see whether there is anything to be made of it all.

## CHAPTER XXII

OUR analysis has ascertained the nature of the temporal machinery which is bound to exist if we observe events in succession. The question which has now to be answered is whether an inspection of that machinery will enable us to account for anything else. And the reply is in the affirmative.

Oddly enough, the first thing which emerges is something which I did not in the smallest degree anticipate. From the outset it was obvious that the analysis would exhibit (1) a series of fields of presentation, each travelling within the next higher field; (2) a series of fixed diagonals, one intersecting another; and (3) a serial observer. But I had not realized that the fixed diagonals would represent the endurances of observing elements in that serial observer, and that each of such elements would be unconscious save at the point where it was intersected by the field of the next higher conscious observer. The discovery of these strictly localized travelling areas of conscious observation was of considerable importance. For it became evident at once that, side by side with the analysis of the machinery of succession, there was proceeding, quite unexpectedly, a detailed disclosure of the machinery of consciousness.

How would you define a *conscious* observer? Define him, that is to say, in such a fashion as to distinguish him from an unconscious observer like a camera? You would begin, I imagine, by enunciating the truism that he is one who is aware of his acts of observation. And you would then realize

that this is equivalent to saying that he *consciously observes* those acts of observation.

It is immediately clear to you that you will reach no explanation of consciousness by that route; but it is equally clear that you have been led to make a statement which is absolutely true and which you cannot possibly retract. But consider what that statement signifies. Consciously observing the primary act of observation is itself a secondary act of *conscious* observation, and therefore, according to the initial statement, it must be consciously observed by a tertiary act—and so on to infinity. You are embarked upon the description of a serial process which has no end to it. And the only way of escape is to go back to the beginning and . . . deny that our friend is aware of his acts of observation. Hence, though the explanation of consciousness eludes you, it becomes clear that, if our observer is to be conscious at all, he must be a *serial* observer, every term in which is consciously observing the acts of observation of the "lower" term.

It is difficult to see how such a serial observer can exist anywhere in the three dimensions of Space alone, but the analysis in our last chapter has shown that he can—and does—exist very nicely in the multitudinous dimensions of Time. Reagent 1, consciously reacting to the cerebral substratum at O, is, there, a presentation in the travelling field of observer 2—is a sectional feature which, in its state of reaction, is being consciously observed. Similarly, reagent 2 is, at GH (wherein it is consciously observing at O), a presentation in the travelling field of observer 3 (*vide* Fig. 10). And so on to infinity.

It will be noticed that, according to this analysis,

a man can be conscious without being conscious of *himself*. In fact, there is, strictly speaking, no such thing as self-consciousness at all. If you consider *any* observer in the series, you will perceive that the observer whose reactions he observes is always an observer in a "lower" term. The self observed is a "lower" self. The existence of a true self, or possibly of a "higher" self, might be *inferred* as an outcome of the discovery that certain phenomena in the substratum were not public property; but such knowledge would be of an acquired character, and it would not be self-observation.

But let us see if the analysis has yielded anything else.

Well, there is . . . but this is a lapse into pure psychology, and must be regarded as such. Psychologists are always seeking for an explanation of how it is that we are *aware* of the passage of Time—aware, that is, not merely of motion or of change, but of the fact that motion and change involve Time transit. That Time should be a length travelled over is, all said and done, a rather elaborate conception; yet that this is the way we do habitually think of Time is agreed to by everyone, both educated and—which is much more curious—uneducated. The child instantly understands its nurse's lumbering attempts at explanation. It scarcely needs to be told that "yesterday" has "passed by" and that "to-morrow" is "coming." How does it, how did we, arrive at this remarkable piece of knowledge?

A theory often hazarded is that attention is never really confined to a mathematical instant. It covers a slightly larger period. That is to say, it has a small extension in the Time dimension.



Now, this small extension is actually given us by Law 3 of the series. The law asserts that the focus of attention in field 1 is the dimensional centre of the focii of attention in all the higher fields: That means that the focus in field 1 is surrounded by a fringe which, however narrow it may be, is being subjected to attention by observer 2. That means, again, that observer 2, whose attention is surrounding and following observer 1's attention in field 1, must perceive observer 1's apparent movement in relation to those stationary (cerebral) presentations in field 2 which are covered by his own dimensionally larger focus. The process is precisely similar to that by which observer 1 perceives objects travelling across his own three-dimensional field. Hence observer 2 (and so the observer at infinity) not only observes what observer 1 is observing, but perceives that individual as travelling from "past" to "future" in Time 1.

(Philosophers will note that "succession in experience" is thus bound to involve the "experience of succession.")

In connection with this overlapping of the focus of observer 1 by that of observer 2, there is another point which may possess some measure of significance. Any focus of attention travelling along Time 1 will come upon irregularities in the substratum—irregularities which we represented by the waviness of the substratum lines in Figs. 7 (a) and 7 (b). In their relation to field 1 and its focus, these irregularities, whether observed or not, are the movements of physical elements in three-dimensional Space. But the slightly wider, overlapping focus of observer 2 may quite well cover a Time 1 length containing a considerable number

of these irregularities, which would thus be presented as Time 1 *pattern* in the part of the substratum covered by that focus. This means that observer 2, following field 1 with his attention, should be capable of directly perceiving in the objective universe characteristics beyond those which present themselves as the spacial groupings and spacial movements of enduring particles. Physical *frequency* would be presented as pattern—a frequency would appear as something concrete. This may ultimately prove to have some formal connection with the observer's interpretations of frequency as sensation. But we should, probably, be exhibiting the matter in its most significant aspect if we said that what the ultimate observer should thus be able to observe directly is a highly important and very remarkable characteristic known to physical science as "*Action*." But of this more anon.

Can we gather anything else?

Yes, we have, at last, the explanation of our dream "effect."

Law 3 asserts that the focus of attention in any lower field is surrounded by the focii of attention in all higher fields. (Which is simply a way of saying that it is the observer at infinity who is, ultimately, attending to the phenomena in that lower field.) Thus, in waking moments, the attention of observer 2 is not ranging to and fro over the limits of field 2, but is following the focus of observer 1 in field 1 moving laterally across field 2. But what if there is no focus of attention in field 1? What if field 1 becomes, as in deep sleep, a blank, owing to the passivity of the cerebrum? Such a situation is exhibited in Fig. 11.

The gap running up the middle of the diagram

indicates the absence of all such cerebral states as are associated with the production of psychical phenomena. So, at the moment (in absolute Time) when field 2, GH, moving up Time 2, is in the position shown, there is nothing in field 1 (the intersection point of GH and  $O'O''$ ) for observer 1 to

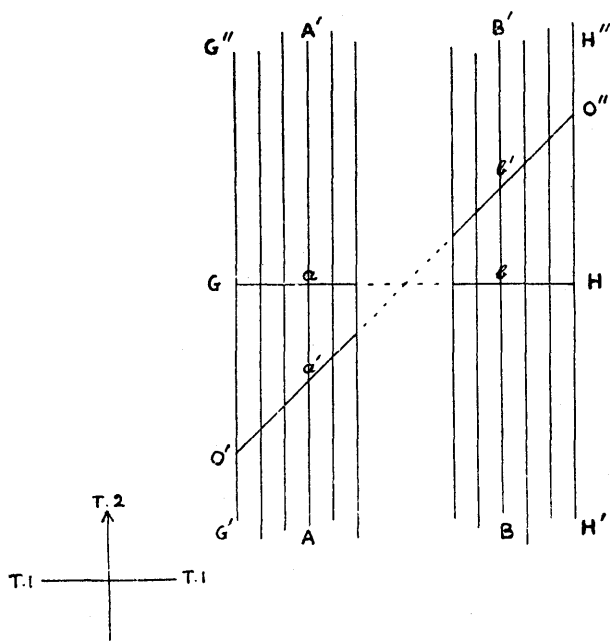

FIG. 11.

attend to. The focus of attention of observer 2 has thus become the *first term* of the series of concentric foci: it has no smaller-dimensioned focus to follow. And so there is nothing to restrain it from moving—at right angles to its Time dimension—in all the dimensions of its field of presentation GH. In other words, when the observer at infinity

finds nothing to attend to in field 1, his attention will wander elsewhere. That such wanderings of attention will account for all the commonly recognized phenomena of dreams will be shown in the next chapter. All that we need point out here is that, in those wanderings, attention will come upon cerebral correlates of sensory phenomena, memory phenomena, and trains of associative thinking which may be either in the "past" (as at *a*) or in the "future" (as at *b*) of Time 1. When waking, attention, following that field 1 point where the travelling GH intersects with O'O", has already come upon the AA' cerebral state (at *a'*), and is going to encounter the BB' cerebral state (at *b'*).

Anything else?

Yes; the results of the analysis agree admirably with all that was discovered during the course of the "waking experiments."

That analysis has sharply distinguished presentation, referable to the original cerebral states, from observation (which includes attention), referable to the observer at infinity. So it is not surprising that it has brought to light no law which *compels* the ultimate observer to direct his attention to any particular phenomenon in any particular field. That such attention is, as a matter of plain fact, habitually directed during waking moments to phenomena in field 1 is obvious enough; but theory leaves us with habit as the only compulsion in the matter. And practice bears this out. In the waking experiments, as the reader will remember, attention, so long as it was allowed to follow an easy, swift train of associated images, came upon nothing but images of the past. The reason now seems fairly clear. That the train of associated images came into observation swiftly and easily showed that the

attention of the ultimate observer was travelling according to habit. But habit keeps it in field 1, and in that field all images relate to the past. Nevertheless, the habit was no *law*. It could be overcome. By determinedly refusing to attend to these readily proffered images, attention in field 1 could be completely discontinued. And, in the rare instants when this was successfully effected, attention in field 2 was free, as in dreams, to slip away along associational tracks extending elsewhere than in the Time 1 "present moment."

Confining ourselves, in this chapter, to the simplest things deducible from the analysis, we have one more point to note.

It is abundantly clear that our serial observer is going to have considerable difficulty in disengaging himself from the trammels of conscious existence. In fact, one cannot see how he is going to manage it at all.

The substratum which provides the ultimate contents of his serial field of presentation is merely the extension (endurance) in many dimensions of Time, of the primary extension in Time 1. That Time 1 extension has a beginning and an end, and these two boundaries are taken into account and appear everywhere in the extensions in the other dimensions of Time. But the fields which travel over the extensions in the second and "higher" dimensions of Time *do not, in any term, move from or towards those two boundaries; they travel straight up between them.* The only field which runs out of the multidimensional figure is field 1. Death—that is to say, the arrival of a travelling field at a boundary—is, thus, not a serial element. It is, like sleep-gaps and the various Time irregularities in the substratum, one of those *solely first-*

*term characteristics*, which—as we saw earlier—must exist in any series which has a beginning.

There may be, of course, arbitrary terminations to the extensions of the substratum in the other dimensions of Time,—some deity may cut them off,—but the analysis indicates that, failing such interference, the substratum persists to infinity in all Time dimensions save the first. For it does not exhibit in those other dimensions the characteristics which, in Time 1, indicate a possible splitting apart of the Time-extended lines at a place farther on in the stretch.

So observer 1 seems to be the only observer who dies.

\* \* \* \* \*

The reader will note, I hope, that the foregoing tenets of Serialism have *not* been deduced from the empirical evidence supplied by our dream effect, but have been obtained by a direct analysis of what must, logically, be the nature of any universe in which Time has length and in which events are experienced in succession.

The case for the dream effect is, therefore, a double one—logical and empirical. The procedure in the book might, indeed, have been entirely reversed. We might have begun by analyzing what was involved in the fact that we experience events in succession. At the conclusion of that analysis we should have noticed—as a very trivial corollary to the disclosures of real importance—the probability of the dream effect. And we might then have described the experiments undertaken to test the validity of this last conclusion. That would have been the usual fashion of a scientific report.

But the circumstances in this case are unique.

It is obvious that, although the "observer at infinity" is nothing more magnificent or more transcendental than one's own highly ignorant self, he is beginning to look perilously like a full-fledged "*animus*." Now, it has been pointed out, in Part I., that belief in the animus must have originated in the study of dreams. Savages and men of poor education, remembering their dreams, could have come to no other conclusion but that, in dreams, they were in a field of existence entirely different from that of ordinary waking life. That belief has been supposed to be childish and absurd. If it were really so, then the case for the animus would have to be regarded as tainted at its source.

I have thought it correct procedure, therefore, to begin by putting the savage before the court, and by showing, empirically, that his dreams did, in fact, occasionally provide him and his "seers" and his "prophets" with ample grounds for the belief that the dream field was something quite other than the waking field, and that his ultimate self enjoyed a degree of temporal freedom denied to the waking individual.

The proofs advanced in the present fourth part of the book can then be dealt with on their merits.

## CHAPTER XXIII

SINCE all observation is the observation of the observer at infinity, all field 1 thinking (successive, automatic experience of the cerebral states situated along Time 1) is the thinking of that not always very clear-minded individual. But is this inspection of field 1 the only sort of thinking he achieves? And is what is presented in that field always so purely automatic as we have assumed throughout the previous analysis?

This ultimate observer (who, be it remembered, is merely your ordinary everyday self) observes in field 2 (GH in Fig. 12) an image  $b$  pertaining to a brain-state  $bb'$ , which state (vertical line) has not yet been reached by the intersection point between GH and  $O'O''$ . In other words, you dream of a future event, and this event is experienced, waking, a day or two later, when field 2 has moved to  $G''H''$ . On the morning following the dream—that is, when field 2 has moved only to  $G'H'$ —you, for reasons good or bad, note down on a piece of paper what you dreamed.

The memory trace of that dream-experience of  $bb'$  is, clearly, not in the brain-state at  $cc'$ , where field 1, O, is situated at the moment of writing down the dream. Therefore,—to be extremely logical,—it must be somewhere else.

The act of writing down the dream from that memory is thus a plain interference with the *automatic* sequence of cerebral events in Time 1. (How far this interference will affect our diagrams is a matter which will be dealt with in the next chapter.)



Also, the total process of reasoning which selects certain details of that dream-memory (which is not in field 1) as being of importance to your intellectual investigation cannot be merely an inspection of brain-states in field 1.

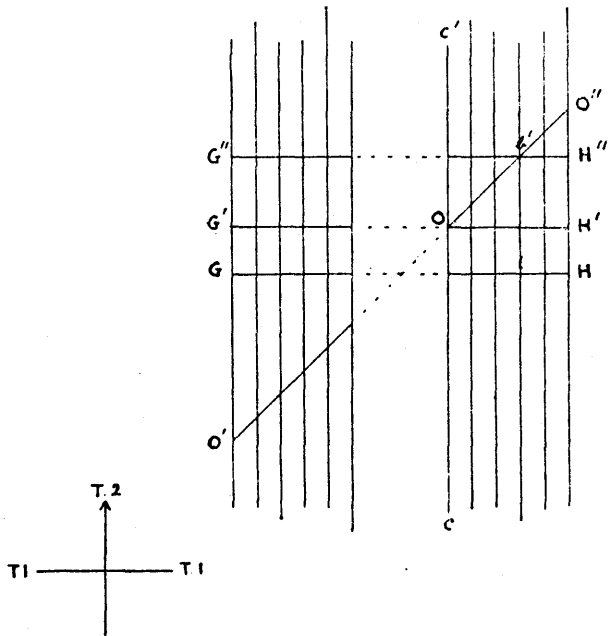

FIG. 12.

We are therefore obliged to allow you the use of memory traces and intellectual equipments which are *additional* to those observable in field 1.

What can we discover about these?

Consider what happens when you fall asleep.

Your focus of attention becomes a four-dimensional focus confronted with four-dimensional

presentations—presentations which cover *periods*, and not merely instants, in Time 1. (For the dreamer, of course, Time 2 is ultimate Time.) These field 2 presentations comprise the sensory phenomena, memory phenomena, and trains of associative thinking pertaining to your ordinary waking life, but all appearing as extended—more or less, according to the degree of concentration of your focus—in Time 1. The substratum to be observed is, as always, stationary. The appearance of movements proceeding in the three dimensions of Space can be produced in the same way as it is produced in field 1 when waking—*i.e.*, by the movement of the focus of attention in the same Time 1 direction—always provided, however, that this four-dimensional focus can be contracted in this dimension to a length not very greatly in excess of that which it has when, during the waking hours, it is following, and centred about, a truly three-dimensional focus in field 1.

But that travelling three-dimensional focus is not there as a guide when, as in dreams, observer 1 is inactive; and the absence of that travelling concentration mark must make it rather difficult for you to keep your four-dimensional focus concentrated almost to nothing in the Time 1 dimension and travelling steadily in that dimension.

This reference to your ability to concentrate is an assertion, of course, that you are more than a purely passive observer; but since we have allowed you the power of *intervening*, we can hardly refuse you that power of concentrating attention which would be bound to be employed in such intervention.

Now, it must be admitted that the conditions above described account very accurately for the

characteristics of dream-phenomena as directly observed. Throughout your dream you endeavour to interpret the dream scenery as a succession of three-dimensional views similar to those which you experience in field 1. And always the excessive Time 1 length of your focus defeats you. Nothing stays fixed to be looked at. Everything is in a state of flux. For always your view comprises the just before and the just after of the instant of Time 1 sought for. And, because of the continual breaking down of your attempts at maintaining a concentrated focus, the dream story develops in a series of disconnected scenes. You start on a journey . . . and find yourself abruptly at the end. You are always trying to keep attention moving steadily in the direction to which you are accustomed in your waking observation,—*i.e.*, forward in Time 1,—but always attention relaxes, and, when you re-contract it, you find, as often as not, that it is focussed on the wrong place and that you are re-observing an earlier scene in the dream story. You begin to follow up what you would recognize, were you awake, as a train of associated images; but your attention relaxes slightly in the middle of the journey, so that what is actually perceived may be the first image in the train followed instantly by the last. And thus you get that curious blending of associated but (really) several-links-apart images known (*vide* Part I.) as an “integration.” That you seem to enter houses without passing through the walls is, of course, one of the most commonplace of happenings in a four-dimensional world.

It is very seldom, however, that you have a perfectly unbroken sleep. The brain stirs, every now and then, to a random current of nervous energy—which means that field 1 comes upon something

observable. Forthwith, attention (1, 2, and the rest of them) is focussed at the spot, and, as attention 1 fades again, there appears among the dream images the four-dimensional image of which the field 1 image has just been the centre, field 1 having moved on again to a blank space. The proceeding here is precisely the same as that which occurs at the moment of falling asleep. Bodily feelings, such as pain and cold, which make themselves felt in field 1, are, moreover, confused with the true dream images, as attention in field 1 comes into and goes out of existence. If attention to such experiences persists, you discover that you are awake.

It is a remarkable fact, however, that you never find pain or any acute bodily feeling mingling with the dream images unless you are actually experiencing such feelings in field 1 at that very moment of absolute Time. And this despite the fact that your attention is travelling among brain-states, past and future, in which bodily discomfort was, or will be, distinctly present to you when awake.

The reason of this may not be far to seek. It is a well-known fact that intensity of bodily feeling depends very largely upon degree of concentration of attention. The soldier in battle often does not know that he has been wounded; you are unaware of toothache when you are running a race; attention to a bad pain will cause a smaller one to *vanish*. While, if you concentrate attention on even a very minor discomfort, this waxes until it becomes almost unbearable. Now, in the absence of the travelling three-dimensional focus of field 1 as a mark, all the other focii of concentric attention become, on our present supposition, less concentrated. Hence, in dreams—the true dreams of unbroken sleep—you are never dazzled by bright suns, deafened by

loud noises, irritated by uncomfortable garments, scorched or frozen or fatigued. Dreams, although they seem real enough, lack all these unpleasant intensity-characteristics of waking life; we are barely aware of the presence of our bodies.

Pain, of course, is, according to the modern view, a sensation as distinct from other sensations as are light or sound. It has a separate neural apparatus of its own, and must not now be confused, as in the past, with that feeling of *discomfort* which accompanies the over-stimulation of sensory organs of other kinds. Pain in the eyes is something different to exceptionally brilliant light. The modern view may be expressed by saying that pain is the most disagreeable of sensations rather than that it is the sense of disagreeableness. Like all other sensations, its range of experienceable intensity must be limited. One cannot perceive colours down to an unlimited degree of dulness, or up to an unlimited degree of vividness. That one does not experience pain of less than a certain degree of intensity is obvious to any experimenter; that unconsciousness intervenes when the intensity of that sensation rises to a certain limit was the outstanding difficulty of the medieval torturer. Pain's extreme unpleasantness, and the fact that it partly distracts attention from other sensations, does not mean that this *range* of observable intensity, from the just perceptible to the absolutely unbearable, is a *long* one. Certainly it is not a range which, like that of colour, contains a great number of separately distinguishable degrees. The fact, then, that pain is not apparent at all to an observer using the relaxed field 2 focus of "dreamland" may mean merely that the *range* of observable intensity pertaining to this unpleasant

and overbearing phenomenon is considerably shorter than the range which pertains to the observable intensities of the sensation of light.

Now, throughout your dream, you *think* about that dream, just as you think about your sensory experiences in waking life. You estimate the significance of what you see in the dream; you make naïve plans to cope with the dream situations; you remember what has happened immediately before in the dream. And this is that additional, non-field-1 thinking and remembering which we are trying to examine.

It would be going too far to say that it is, in every sense, the thinking of a little child, for it involves conceptions which pertain to adult life,—such as, for example, political ideas. But we may all admit that it is thinking of an extraordinarily feeble kind as compared with that which accompanies the inspection of the successive brain-states in field 1. Yet it is, very clearly, thinking of the same general character as that of our waking speculations. It is, as we have seen, based upon the idea that the perception of a succession of three-dimensional aspects is the only possible method of observational experience; it ignores the little before and the little after of the Time 1 instant sought for, regarding this as being mere instability in what is observed; it memorizes what is past in the dream in the same would-be-three-dimensional fashion; and it causes attention, when concentrated, to travel in the *accustomed* Time 1 direction, despite the fact that Time, for the thinker in question, is at right angles to that dimension.

It is true that one does not ascertain all this from observation of the dream, but from observation of the memories of the dream, after waking. But

it is not observer 1 who is inspecting those memories. *They are not in his field.* Such remembering, when awake, of what you saw in the dream and of how you thought about it during the dream is something which you accomplish without the assistance of observer 1.

Let us consider here the imaginary case of a purely automatic observer 2 whose remembering and thinking were completely analogous to those of our first-term observer. This supposed super-individual would be equipped with memory traces extending in an associational network at right angles to Time 2. His thinking would consist of the wanderings of attention over this associational plexus—wanderings to and fro in Space and backwards and forwards in Time 1. It would be thinking of a glorified, four-dimensional kind, in which Time 2 would be the only apparent Time dimension, and in which the four-dimensional way of regarding the substratum would be the natural and obvious way. This observer might be aware that all four-dimensional things were composed of an infinite number of three-dimensional sections; but he would never perceive, or try to perceive, as we do in dreams, one of those sections as unique, and the remainder as unstable, confusing additions.

Now, the records of the wanderings of the real observer 2's attention in dreams—the records which enable you to remember those dreams—*must* be traces extending in four dimensions (Time 1 and the three ordinary dimensions of Space). And, whether these traces be in the cerebral substratum or in the Time-travelling observer 2 (who is a four-dimensional entity distinct from the substratum over which he moves), or anywhere else, they are bound to constitute some sort of an associational network.

So we are confronted with the case of an observer who actually does possess the mental *structural equipment* adapted to the viewing of presentations in their four-dimensional entirety, but who endeavours, nevertheless, to regard such presentations as merely three-dimensional phenomena.

Your thinking, in the absence of observer 1, involves, therefore, something over and beyond the mere *inspection* of a four-dimensional associational structure. It involves *interpretation* of that structure.

So it begins to look as if Professor W. McDougall were right in one main particular. For nearly all his arguments in favour of the existence of the animus amount to an insistence that what he calls "*meanings*" are interpretations by the animus of what is presented in the way of imagery by the brain. Yet it would be difficult for us to accept McDougall's view in its simple entirety. There is an opposition theory too strong and too eminently reasonable to be ignored. It is, I think, best expressed by Professor J. S. Moore, who declares that "*Meaning is context,*" and proceeds to argue that the meaning of a specific idea is simply the fringe of associated ideas which constitute that context.

The answer given by Serialism seems to be that Moore is right, but that McDougall, nevertheless, is not wholly wrong.

If meaning is given by context,—by attendant associations,—it must be given by the fringe of a partially relaxed attention. And this is borne out by the fact that, when our attention to an object is greatly concentrated, we notice the quality and form of that object at the expense of noticing its meaning. Now, the attention of observer 2, when surrounding and following that of a waking observer 1, is, on our theory, kept concentrated in the Time 1 dimension; and changes in concentration take place mainly in the three dimensions of Space. So that contexts, to the waking observer, are mainly relations of spacial position and spacial motion. And that is



certainly true of the meanings which he attaches to what he perceives. The contexts supplied by the very slightly overlapping fringe of attention in the fourth dimension are those which exhibit the Time-travelling of observer 1, and a hint of Time 1 *pattern* in the substratum.

All of which fits in very nicely with Moore's definition.

But to our imagined automatic observer 2, thinking—in the *absence* of observer 1—in four-dimensional fashion, contexts in the fourth dimension should be interpretations as clear as are those in the three dimensions of ordinary Space. Yet it is just these fourth-dimensional contexts which are not, to the real observer, clear interpretations. And they are not clear—to him—because they are *themselves misinterpreted*—by him. Instead of being regarded as fourth-dimensional associational extensions, they are regarded as perplexing *three-dimensional instabilities*. And backward travellings of attention, from the future to the past of Time 1, are simply not noticed at all. Interpretations of that kind must be interpretations by the *observer* of the context fringes concerned.

Here an analogy may be of service. Consider a child who, through a certain amount of experience in reading two-dimensional sheets of printed music, has acquired the habit of interpreting those sheets as arrangements of one-dimensional chords to be followed by attention in succession from left to right. When reading such a sheet he is in the position of an observer employing field 1. To extend the analogy so as to exhibit him in the position of an observer during sleep, we should have to imagine him equipped with a focus of vision which could not be concentrated enough to admit of its containing one chord only at a time. But we can get over that difficulty by supposing him, now, to be provided with a sheet in which the chords, instead of being clearly separated, are so crowded together that each partly interlocks with its immediate neighbours to right and left, the result being

that no chord can be seen singly by itself. Now, none will deny that the child, presented with such a sheet, would begin by trying to read the puzzling thing in the old, accustomed way, or that the habit which compelled him to this would be, not in the sheet, but in his mind. So it is that the habit of three-dimensional interpretation which afflicts us in dreams is not a feature of the four-dimensional phenomena observed, but a characteristic in ourselves as observers. As for our inability to notice in dreams the movements of our attention backwards in Time 1, the habit of interpretation established in the ultimate thinker is amply sufficient to account for this. No child, reading a sheet of music, observes what his eyes pass over when he moves them back to the beginning of a new line. You (I hope) have read every word from the beginning of this book, and your gaze has flashed thousands of times from the right edge of the page to the left; but never once have you read a line backwards, or even noticed what the backward aspect of a line looks like. In fact, even now that you try, you cannot perceive that aspect; and the nearest approach to a realization thereof that you can achieve is that which you obtain by viewing a word written backward, but still from left to right—looking-glass fashion. And the habit which blinds you to that aspect is not in the printed page, but in yourself.

So we are driven to the interesting conception of an ultimate thinker who is *learning to interpret* what is presented to his notice, the educative process involved being his following, during the waking hours, with unremitting, three-dimensional attention, the facile, automatic action of that marvellous piece of associative machinery, the brain.

This, admittedly, is a complete reversal of the old-time animist's conception of the "higher" observer as an individual of superlative intelligence producing the best effect he can with the aid of a clumsy material equipment. But it seems to me there is no getting away from the plain evidence afforded by the character of our dream thinking. Whatever capacities for eventually superior intelligence may be latent in the observer at infinity, they are capacities which await development. At the outset brain is the teacher and mind the pupil. Mind begins its struggle towards structure and individuality by moulding itself upon brain.

Evolution has worked for possibly eight hundred million years towards the development of brain. To-day, as Professor McKendrick points out, nearly all the functions of our bodies are operating towards the end of the adequate nutrition of the *grey matter*. And it now appears that, apart from its self-sustaining and self-developing activities, the brain serves as a machine for teaching the embryonic soul to think.

We are now in a position to consider what is the *origin* of the habit which keeps the ultimate observer's attention focussed in field 1.

In field 1 he has to deal with merely a simple succession of three-dimensional phenomena in a three-dimensional field. But in field 2 he is confronted with a view of four-dimensional phenomena in a four-dimensional field. And, in addition, he has these four-dimensional phenomena duplicated. For example, he may find at *a* (Fig. 11) a memory revival of a preceding event in Time 1. And he has also, somewhere between *G* and *a*, the original event which originated the memory traces subsequently revived. In field 3 the substratum (see

Fig. 10) is crowded with five-dimensional phenomena (containing, however, none that are not already represented in simpler four-dimensional form in field 2); and these phenomena, owing to the less concentrated area of the focus of attention, are of less intensity than are those in either field 1 or field 2. And the intelligibility of the presentations gets worse, and their vividness gets less, as we proceed up the series.

It is in field 1, then, that, for the infant, phenomena first become *distinguishable* at all. And his attention stays where there is something to be attended to.

Next, we know that, even within the limits of field 1, an adult's attention may be attracted from without as well as directed from within. We know, also, that the directing of attention away from a point of attraction is a process which has to be learned, painfully, at the schoolroom desk. The young child's attention must be, therefore, largely at the mercy of attraction. And we know that the greatest attractors of attention are the cruder bodily pleasures and bodily *pains*. These exist only in field 1. Thus pain performs a service other than purely physiological.

Finally, the child learns quickly enough that in field 1 he can *intervene* to obtain those pleasures and avoid those pains. And that, very rapidly, becomes the dominating aim of the man.

\* \* \* \* \*

Reviewing the foregoing parts of this chapter, we see that ultimate Mind—the Mind which can appreciate only the most elementary aspects in the complex structural equipment at its disposal—must always exhibit itself as something external to any

*structural* conception thereof that we can attempt to form.

\* \* \* \* \*

In Part I. of this book we carefully refrained from tackling the question as to whether the internal *directing* of attention was to be attributed to the ultimate observer, or to be regarded as originating in the purely automatic internal condition of the brain. We contented ourselves with noting that, if we regarded the ultimate observer as the responsible agent, we should be according him the status of an animus, with power of intervention, since the concentrating of attention is known to have a marked effect in the formation of memory traces.

It would be best, however, in order to avoid any possible trap for an incautious thinker, to show that such directing of attention—such intervention—must be attributed to the observer at *infinity*.

The question is, really, whether, in any higher field, attention may be bound to coincide with some feature in the substratum analogous to the "maximum flow of cerebral energy" in field 1.

We saw, earlier, that the analysis had brought to light no law which *compelled* attention to direct itself upon any particular phenomenon in any particular field. It was pointed out that attention, which is referable to the observer at infinity, was sharply distinguished by the analysis from that which was presented to attention; that is, from the contents of the substratum. Now, "maximum flow of cerebral energy," or anything analogous thereto in any higher field, is a substratum feature, and, as such, categorically distinct from "focus of attention." Theoretically the two things may be

separated. And that this theoretical distinction is a practical, real distinction, and not merely a bit of metaphysical hair-splitting, is shown by the "waking experiment." For there the one thing is present and the other is absent.

There is one great difference between the conditions in this waking experiment and those which obtain in dreams. In the former case the cessation of field 1 attention, which sets free field 2 attention, *is not accompanied by the cessation of body-maintained cerebral activity.* The eyes may be open, transmitting to the cerebrum light-stimulations differing in intensity at different parts of the field of vision. Noises of various degrees of loudness are assailing the ears. Cerebral action is flooding associational tracts, presenting those hosts of associated images to which attention (this, as we saw, is the very essence of the waking experiment) must be determinedly refused.

This shows that the theoretical distinction between the focus of attention of the observer at infinity and any line in the substratum which it may habitually follow is a real one, and so we are bound to regard it as always *possible* for such focus to be separated from any such line. And, where the two things do coincide, the observer at infinity must be regarded as an accessory, passive or active, to that coincidence.

All of which, of course, is to admit that the observer at infinity is an individual potentially capable of exercising what is called "*freewill*,"\* though how far he may be said to have developed that capability is quite another matter.

That he can, and does, direct attention in field 1

\* Nobody means by "free" will a thing actuated by no motive whatsoever.

is now plain enough. But his control in field 2 seems to be as limited as is his comprehension of that area. We may note, however, that, throughout his dreams, his rudimentary intelligence is extremely active in attaching interpretations to that which he observes. (Indeed, as I remarked earlier, he is a master-hand at attaching wrong ones.) And it is a matter of common knowledge that he employs this function of interpretation in weaving a dream *story*—a drama of personal adventures—out of the various presentations upon which his attention becomes focussed. If he can direct his attention at all in this field, he can modify the trend of that story; can, in fact, build the drama to please himself. He has an almost unlimited wealth of material. He is, as we have seen, potentially capable of exercising that control, and, judging from my own experience, I am disposed to think that he does do so to a small extent, and that his effectiveness in that respect increases with practice. Adults, I fancy, are not so much at the mercy of their dreams as are children; they can (certainly I can), occasionally, alter a situation which fails to please.

These, however, are matters for the psychoanalyst. But perhaps when we have learned to interpret fourth-dimensional contexts as "present" wholes,—to think four-dimensionally,—and to master the movements of our attention, we may find field 2 of greater interest than field 1. But that development in comprehension and control is not likely to occur so long as we continue to spend nineteen hours out of the twenty-four in practising three-dimensional attention in field 1.

We must live before we can attain to either intelligence or control at all. We must sleep if we

are not to find ourselves, at death, helplessly strange to the new conditions. (The universality of sleep is a remarkable feature in Nature's plan.) And we must die before we can hope to advance to a broader understanding.



## CHAPTER XXIV

CONSIDER, now, the situation represented in Fig 13.

When (in absolute Time) field 2 is at GH, the substratum between  $a$  and H comprises an ordered arrangement of three-dimensional cerebral states, all in the future part of Time 1. That ultimate thinker who is the observer of dreams—which involve the observation of field 2 as present—observes, let us say, at that moment, one of these future states  $b'$ . After waking, when field 2 is at G'H', and field 1 is at O, this thinker intervenes at O. That intervention we will suppose to be due to his memory of the dream; just as every word which I write in this book is intervention due, originally, to my memories of similar dreams. (The diagram, however, will serve equally well to illustrate the results of an act of intervention originating in any other activity of the ultimate observer's partially trained mind.) Now, we have to note that such an act of intervention may result in the complete alteration of part of observer 1's future career. Taking the train to Dover instead of the express to Southampton may lead to his being decapitated by Russian politicians instead of being clubbed by a New York policeman. So he may never encounter the cerebral event represented by  $bb''$ ,—the event perceived in the dream,—and may, instead, when field 2 is at G''H'', encounter a totally different event,  $c$ .

In the sort of life led by the average civilized man, intervention has seldom any very great effect in altering future experience. We live too much in ruts for that. A man may, on Monday, take a

ticket for a Saturday matinée, and he may, during the next few days, perform countless little acts of intervention; but these will not necessarily prevent his occupying his seat on the Saturday, or prevent his seeing on the stage a scene of which he may have dreamed on Monday night. The intervention

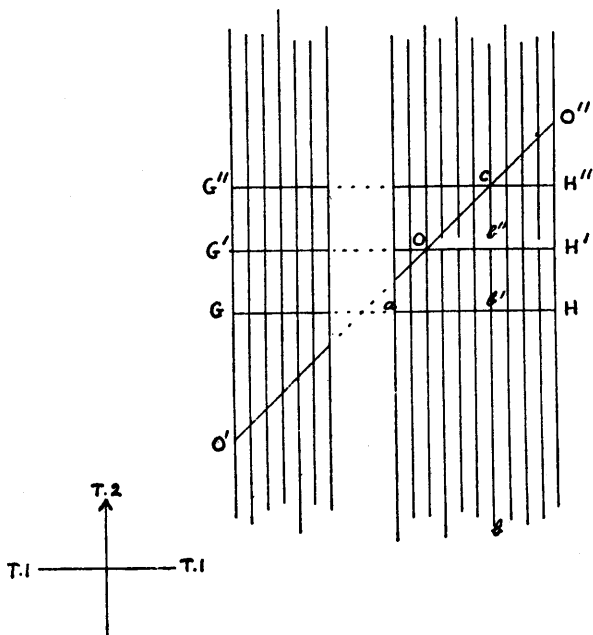

FIG. 13.

at O may, thus, alter some of the events between O and H' while leaving others unchanged. In fact, if we represent the alterations by breaks in the vertical lines, just above OH', the result would be the sort of thing shown in the figure.

It is to be noticed, however, that these breaks in the verticals are to be regarded, not as fixed sub-

stratum features which exist before (in absolute Time) observer 1 reaches O, but as *changes* in that substratum which occur at the instant when (in absolute Time) this observer reaches that point. This means that the breaks are being represented as due to intervention, and *consequent* upon the ultimate thinker's interpretation of the event which he has, in his dream, perceived at *b'*. (We saw in the last chapter that such interpretation cannot be represented as any sort of context or trace in the substratum.) To regard the breaks as pre-existing (in absolute Time) fixities in the Time-map travelled-over would mean that the ultimate thinker would encounter the new event whether he had the dream of the old one or not: the breaks would not be occurring as the result of the *dream*.

We saw in the last chapter that all movements of attention require passive consent or active intervention on the part of the observer at infinity. Where such movements involve a departure of attention from that line in the substratum which represents the flow of maximum cerebral energy, we have active intervention accompanied by substratum changes similar to those shown in Fig. 13. But, considering the degree of intelligence which the intervener exhibits when the brain is dormant and not employable as an aid to his reasoning, we cannot conceive that his interference with cerebral thought processes amounts to very much more than an insistence that the machine in question shall operate towards a certain end of his own. The intervener, in fact, is analogous, not to a skilled musician composing with the aid of a piano, but to the amateur user of a pianola, whose interferences with the complex performances of that instrument is limited to the changing of one perforated roll for another.

That the change in the substratum takes place all along  $OH'$  instantaneously (in absolute Time) is obvious enough when we regard the effects of the intervention from the standpoint of our more customary, three-dimensional philosophy. None can deny that, when he takes a step to prevent an otherwise probable event from occurring, the probability of that event (however distant) being encountered is altered at the precise instant when he takes that step. Translating that into the language of four-dimensional philosophy, it means that the probability of observer 1 encountering the event  $bb''$  when (in absolute Time) he arrives at  $c$  is changed at the "precise instant when" he intervenes. That "precise instant" is an instant in the Time which times his travel along  $O'O''$ , which Time is Time 3—the absolute Time for the diagram. The breaks occur, therefore, when (in absolute Time) observer 1 reaches  $O$ , which is when (in absolute Time) field 2 reaches  $G'H'$ . The altered course between  $O$  and  $H'$  will be, in all its parts, a mechanical sequence just as perfect as before.

It is clear that the alteration of the substratum along  $OH'$  must affect also that extension of that line as a plane (perpendicular to the paper) which represents the line's endurance in Time 3. The "future" part of that plane must change with the change in the line. And so on through all the futures ahead of  $O$  in all dimensions of Time. Consequently, nowhere in our serial Time-maps can we pick out a path ahead of  $O$  which is absolutely determinate in all its parts.

It is, perhaps, unnecessary to point out that the ultimate "observer" and the ultimate "thinker" are, throughout the analysis, the observer and the thinker who remain unaccounted-for at the completion of each stage of that analysis,—the individual

who is travelling over the last Time dimension shown in diagrammatic form. They are, thus, always one and the same entity.

\* \* \* \* \*

The present writer cannot know how the reader feels about the matter, but at this point he himself would be grateful for ten minutes' interval in which to sort out and rearrange the pile of information so far provided by the investigation.

The result of that process, in his view, must exhibit itself as follows.

Serialism is the perfected statement of the relation between observer and observed.

To analyze that relation, you must begin by regarding both the related parties (observer and observed) as objects to yourself, the thinking subject,—you must put both into your picture. Consequently, you are obliged to take, as the observer for analysis, not yourself, but another, imagined, individual, who is assumed to be similar to yourself. Let us call him, for the sake of brevity and euphony, Jones.

You begin by studying Jones as a *conscious* individual. All that you here discover is that he cannot possibly be conscious unless he is *serially* conscious.

Noting this, you proceed next to examine him as an individual who experiences in *succession* all the states of that which he observes. This involves your making your picture one dimension larger than Jones. Whereupon, the analysis exhibits Jones to *you* as a conscious, psychical individual travelling along a Time dimension. But it gives no indication that he is anything more than an automaton.

You find, however, that, in proceeding thus far

in your analysis, you have logically committed yourself to enlarging your canvas by yet another dimension. Whereupon, Jones 1 appears to you as observed by another, larger-dimensioned observer, who, however, is not yourself, but still Jones,— Jones 2,—while Jones 1 now definitely exhibits himself to you as the mere perishable automaton which materialism has always held him to be. Jones 2, however, appears as imperishable.

Continuation of the analysis shows you a series of Joneses each observing the Jones of the next lower term. All these are imperishable except the first; and all are automatons except the last, about whom you do not yet know enough to dogmatize.

Here you pause to revise your work, and to consider, in particular, the *legitimacy* of the steps in your analysis. But you can find no flaw. Nowhere have you slipped unwittingly into an attempt to analyze yourself. Nowhere have you substituted yourself for the objective observer you are considering. You have stuck throughout to Jones; and Jones is fair game.

You note, next, that this serial Jones is *serially* conscious in exactly the way demanded by your initial conclusions regarding consciousness.

Now, Jones is similar to yourself. Consequently, you should be able to check the accuracy of your hitherto purely logical discoveries regarding Jones by reference to your own experiences.

A serial Jones must be able to observe the actual passage of himself along a Time dimension. Since this would apply equally to yourself, you have an explanation of how it is that all men, educated and uneducated, and all children, are agreed about the passage of a fundamental but indefinable "Time."

You note that, when Jones's brain is entirely in-

operative, Jones 2 should be able to observe images of the experiences successively provided for him by the brain when in its active state. This, certainly, would be a very curious happening. Nevertheless, on turning to your own experiences, you find that, when your brain is apparently asleep, you "*dream*," and do experience images of waking events.

You make the still more startling discovery that the images perceived by Jones in such "*dreams*" should include some relating to his future waking experiences. You test this on yourself and find it true.

You have discovered, during the analysis, that the focussing of attention is a function of the ultimate Jones (the last Jones considered in the series), that attention thus focussed is a psychical element entirely distinct from that feature in Jones's substratum upon which such attention happens to be focussed, and that there is no law in nature which compels attention to be focussed anywhere in particular in the substratum. This suggests that, when attention *is* focussed anywhere in that substratum, such focussing must be due to the action of the ultimate Jones. If that is indeed the case, the ultimate Jones should be able to shift attention from field 1 to field 2 even when the waking brain is supplying experiences to Jones 1. You test this upon yourself by means of the "*waking experiment*," and find that it holds true.

Since the ultimate Jones can direct attention, he can intervene to alter the course of mechanical events. You prove the truth of this in your own case by making the mechanical waking action of writing down one of your dreams of future experience.

From a study of the mental operations involved in

this last action of yours, you conclude that *your* observer at infinity must be capable of remembering and thinking without employing the assistance of the brain. You realize that, in this case, such remembering and thinking should be apparent when the brain is asleep and observer 2 is inspecting the fixed cerebral states arranged elsewhere along Time 1,—*i.e.*, is dreaming. Experiment satisfies you that you do, in fact, when dreaming, think about your dreams and remember previous events in those dreams.

Examination of your dream-thinking and dream-remembering shows that, though your brain is asleep, you, as the ultimate observer of your series, try to continue both observing and remembering in the same three-dimensional fashion as you do when the brain is awake and you are observing its successive states presented in field 1. This, you realize (since your dreaming attention is four-dimensional), is bound to result in a curious and confusing temporal instability in the images observed and remembered,—an instability which must render the dream images much less *definite* than are those other "images" which you can produce in waking imagination. Experiment shows that this is true.

From that you are bound to conclude that the ultimate observer's mind is moulding itself through observation of the successively presented states of the brain, and is, therefore, learning to think in three-dimensional fashion. All of which insists that your dream-thinking must be, at the present stage of your life, inferior to your waking thinking (when, as the ultimate observer, you, with your power of intervention, are utilizing the assistance of the brain). Examination of the degree of lucidity of your dream-thinking bears this out.



The results of the analysis assure you that, in dreams,—Jones's or yours,—bodily sensations should be much less intense than they are in waking life. Experiment shows that this is the case.

You discover excellent reasons why the ultimate Jones should keep his attention focussed upon Jones 1 so long as the brain is providing Jones 1 with anything to observe. This, you find, is what you do yourself.

Here you make a conjecture. But it is your first and only one; and the point involved is of quite minor importance. In the absence of anything observable at the place in Time 1 where Jones 1 happens to be, Jones 1 ceases to provide a travelling guide-mark for Jones 2; and it seems to you likely that, in these circumstances, the movements of Jones 2's attention in field 2 are likely to be extremely erratic. This, you find, agrees with your own experience in dreams.

Finally, the conception of the observer which you have so far obtained provides you with satisfactory teleological reasons for the eventualities of birth, three-dimensional life, pain, sleep, and death.

\* \* \* \* \*

*The ultimate thinker or interpreter—the member of the series whose thinking is something over and beyond mere observation of the contents of his field—is that observer who, like the ultimate Time, remains unindicated in each diagram of the series. In the first term—exhibited in Figs. 7 (a) or 7 (b)—he is observer 1; in the second term he is observer 2, his field being pictured in Fig. 9. And so on to infinity. It is essential that we consider the series so far as to include the second term, otherwise the serial relation will not be fully disclosed.*

*But there is no practical object to be achieved by considering the remoter terms. You will find that no new kinds of relation between observer and observed become apparent in the third term. Carrying the analysis further means merely pushing back the ultimate observer and thinker, with all his peculiar functions, and the insertion of additional reagents, all reacting to the contents of the substratum, and all unconscious save where this ultimate observer employs them to gain an acuter view.*

*It is sufficient, then, for you to picture the world as containing observer 2; that is, as the field 3 of Fig. 9. This gives you the complete serial relation.*

## CHAPTER XXV

[NOTE.—Unless the present reader is interested in the science of physics, he is recommended to skip this chapter.]

PHYSICS, shortly before the Relativist landslide had begun to make itself fully felt, suffered from two shocks of great magnitude—so great, indeed, that the damage done has not even yet been fully determined. In the first of these, matter, after standing for centuries as the most fundamental of all things, was swept aside, leaving the “*Electron*” exposed as, apparently, the true basis of the objective universe. But the second shock, which resulted from the discovery of a curious entity called the “*Quantum*,” effected an even profounder change in the situation.

The quantum appeared to correspond in some cryptic fashion to the actual atom of a certain physical quantity which had for long (even in the days when it could be thought of as nothing more concrete than mathematico-physical expression) been recognized as by far-and-away the most fundamental thing of its kind. This physical quantity is called “*Action*.” It must not be confounded with “action” in the conventional sense. It is a quantity which involves in some queer way kinetic energy multiplied by Time, or momentum multiplied by Space; but the general reader need not perplex himself concerning the meanings of these very curious expressions. In the present state of physics, anyone who tries to make a mental picture of what is signified by “action” is simply seeking for trouble;

and the layman would be well advised to settle with himself that the word, when encountered, means merely a known, but as yet unidentified, fundamental entity.

“Action,” says Professor Eddington, “is generally regarded as the most fundamental thing in the real world of physics, although the mind passes it over because of its lack of permanence; and it is vaguely believed that the atomicity of action is the general law, and that the appearance of electrons is in some way dependent on this. But the precise formulation of the theory of quanta of action has hitherto baffled physicists.”

It is clear enough, however, that if we consider any atoms of “action” in terms of Serialism, we must think of these as little entities dotted (so to say) along Time 1 and enduring in Time 2—that is, as real entities in field 2, as real as are the electrons in field 1.

Before the discovery of the quantum, a principle called the “Principle of Least Action” had firmly established itself as one of the great basic generalizations of the science of physics. The principle relates to the paths followed by bodies possessing “mass” when they change from one grouping to another later on in Time. And it lays down that these paths will be such that the “action” (the energy multiplied by Time quantity) will be the least possible in the circumstances. The principle is, thus, capable of prophetic application.

There is another exact science which can claim to be prophetic. It is a purely mathematical one, differing from physics in that it assumes that the calculator has no means of ascertaining what, if any, laws of mechanical cause and effect are involved in his problem, and so ignores all such and arrives at

his result by the estimation of "probability." Physics can prophesy the path immediately ahead of a planet by the "Principle of Least Action": this other science—the mathematical science of "*Probability*"—can prophesy the same thing just as accurately by means of what is called the "Principle of Greatest Probability." The man-in-the-street is employing this science unwittingly when he says, regarding some future event: "The chances in its favour are so great that its occurrence is a moral certainty." The science in question regards all future events as "probabilities," and what it tells you about them is their degree of probability. When this is so great as to make the occurrence a certainty, the science becomes as truly prophetic as is physics.

To the exponent of this mathematical science, there is one, and one only, future condition of the universe—that which, considering all the present circumstances, has the "Greatest Probability." To the physicist, there is also one, and one only, future condition of the universe—that which, taking all present circumstances into account, will involve the "Least Action."

Since the future condition envisaged is the same for both sciences, we are here considering two principles leading us to one and the same conclusion by, apparently, totally different routes. And we should have good reason to suspect that these two principles must be merely different ways of regarding some single, underlying principle in the construction of the universe.

Now, it so happens that Eddington, delving in the realm of mathematical physics, noticed that a certain very unique feature was apparent in both a "probability" and in "action." This suggested,

not only that the two things were related, but that the relation must be of a certain very definite mathematical character. Then came the confirmation. This mathematical relation had been arrived at without taking into consideration the two "Principles"; but, on applying it to the mathematical expressions of those principles, he found that it actually converted the "Principle of Greatest Probability" into the "Principle of Least Action," and *vice versa*. These became, therefore, merely two different ways of expressing one and the same underlying fact.

To sum up, Eddington identifies "action" with what is called a "function" of a "probability." "Action," he holds (the general reader need not worry about understanding the mathematics), is, "minus the logarithm of the statistical probability of the state of the world which exists." ("Exists" means, exists at the place in Time considered, without reference to whether that place be past, present, or future.)

The reader may not understand anything about logarithms; but he will be able to see that the probable "state of the world" envisaged in the sentence is not a probable state of the "action." For, if so, the statement would assert that "action" was minus the logarithm of the statistical probability of the state of itself! What sort of a world, then, does Eddington mean by "the world which exists," seeing that it is not a world of "action"? The answer can only be (since Eddington's identification depends upon "action" being regarded as the most fundamental entity) that it is a world considered as comprised of certain entities *less fundamental* than "action."

Having determined this point, we are in a position

to consider what the identification signifies when expressed in non-mathematical language.

In the first place, we have to bear in mind that Eddington is writing as a Time-dimensionalist, and that, to him, units of action are entities existing in a positive, present universe. On the other hand, "probabilities" are expressions employed in a science which regards Time as a mere abstraction. So that the "probable" future groupings which it has in mind are groupings of certain entities pertaining to a world of fewer dimensions than Eddington's.

Hence the identification is a statement reconciling two sciences—one dealing with probable groupings of three-dimensional entities, and the other with existing groupings of higher-dimensional entities. And it means this: Wherever we (thinking in terms of three-dimensional science) consider that there are, in the future of imaginary Time, events of maximum probability, we must (when we think in terms of any Time-dimensional science) consider that there are, in a present, existing Time-field, units of action (real configurations of more fundamental entities) arranged as pertains to a condition of least action.

To us, it is obvious, at once, that the statement about the "probable groupings" is a statement concerning what would be thought of as "things" by a physicist who was considering our field 1 as being his present, existing world. While the statement about the corresponding "action" is a statement concerning what would be regarded as things by a physicist who was considering some field higher in our series as being the present, existing world.

The *substratum* with which we have been concerned in our earlier chapters is of a very simple

kind: it grows merely by the straightforward addition of dimensions of Time. All the complicated part of the serialism in our diagrams—the system of observers, fields, and reagents—is purely psychical. If we reject the hypothesis of the atomicity of action, our substratum is a multidimensional continuum of the following kind. The atoms of matter—or, let us say, the electrons—separated in Space, would extend in Time 1 as unbroken world-lines, which, in turn, would extend in Time 2 as world-planes. On that continuum we should have to (as we have done) impose our psychical system of travelling fields. The result would provide us with all that is essential to that Serialism which this book is attempting to expound. If, however, we adopt the belief that there are atoms of action more fundamental than electrons, we can no longer regard the contents of field 2 as simply the contents of field 1 temporally extended—for the action atom configuration involves a temporal atomicity which not only breaks up any such attempted world-lines, but shows them as streams of atoms more fundamental and higher-dimensioned than are those of field 1. That modification would not, however, invalidate the results we have obtained in previous chapters by analysis of the psychical side of the picture.

\* \* \* \* \*

There is, of course, no reason why a Relativist should not regard the field 2 of Fig. 9 as deformable. This would make field 3 deformable in those four dimensions. But that would not affect the validity of the Serialist's argument. Field 3 might be deformable in all five dimensions without troubling him. It seems to me, however, that the



simplest combination of Serialism with a Relativist view is that of regarding field 2 as the Relativist's real world of "point-events"—his world which is the same for all observers and so across which all physical observers move with a common Time dimension and share a common field 1. Field 3 would extend upwards and downwards in Time 2 from that four-dimensional base.\*

\* This would involve treating the Relativity problem itself in serial fashion. The geometrical character of the common-to-all field 1 would be similar to that of the whole region around the cone apices in Relativity diagrams; but each observer 1 would regard the field as three-dimensional and as travelling "straight" along his own world-line. If we insist that the field must move as a whole in some absolute direction, we have it that its path must lie somewhere between the two light-tracks; but a little consideration will show that the search for such an absolute direction of travel is the search for the absolute position of a universal reagent 1 (treated as an inclined plane in a cube, with Time 2 as time). This is, clearly, the Relativity problem introduced anew in a higher stage of the analysis, and a solution would be sought for on the usual lines—by regarding the whole cube, representing a five-dimensional world, as deformable.

## CHAPTER XXVI

IT is to be feared that the observer's power of interference does not suffice to make him wholly master of his fate. For there are other observers, employing similar capabilities. While our friend is in bed, dreaming of the happy probabilities of his future, some enemy, afflicted by this mania for intervention, may proceed to fire the house and reduce those probabilities to might-have-beens. (They would always remain, of course, entities in the substratum past of Time 2, but entities never encountered by field 1.) And, if the observer may owe his Time 1 end to the intervention of other observers, it is fairly certain that he owes his beginning to nothing else. Before his birth he can be nothing but a probability in the future of the race.

This brings us to the question of how the fields of different observers are related.

Our knowledge that such observers can intervene helps us to see that their respective field 1's must, in their motions along Time 1, keep very nearly in line. For, if the field of an observer A lagged behind that of an observer B, and A were to intervene in B's career at that point in B's substratum which was level with A, then B would find his experiences in *his* field 1 miraculously altered. In fact, he might find himself miraculously dead, having been slain by A, unknown to himself, some little way back. And that sort of thing does not happen in our experience.

Now, these field 1's are merely the intersections

of the fixed diagonal reagents by the field 2's. Since, then, the field 1's move approximately in line, the fixed diagonals must lie in approximately the same plane. But it also follows that the field 2's, in moving up Time 2, must maintain a fairly even "dressing."

Relativity does not, at present, deal with the *movements* of these field 1's at all. It concerns itself merely with maps of the substrata over which these fields move.\* If, however, we were to apply Serialism to Relativity theory, we should find, perhaps, that our fixed diagonals in two dimensions of Time could not be regarded as being strictly in the same plane. But the extent to which the fields or diagonals could be out of exact alignment would be considerably limited by a law which insisted that, if any observer's intervention in his field 1 consisted in his sending a light-ray to another observer, that light-ray would have to arrive at the second observer's field 1.

Let us consider, however, the case of a mother and her child. It is clear that, at the moment of the child's birth, the field 1's of these two individuals must coincide. This involves that their field 2's are, at that point, in contact and at the same instant in Time 2. It also involves that their respective diagonal reagents are, at that point, in contact and directed along the same diagonal plane.

Suppose, then, that we were to draw a plane diagram of the "family tree" of the entire human race, employing one dimension of the paper as Space and the other as Time 1. The result would be a network with numerous points of intersection representing marriages, and numerous branchings-

\* Maps from which it derives a common-to-all map of "point-events" separated by "intervals."

off representing births. And you would find that you could trace in that network an unbroken connection between any two points that you chose to select; human families are all related in that fashion.

If we were to assume that this diagram exhibited only the *cerebra* of the individuals concerned, it would be the first, stage 1, temporal extension in a Time analysis in which we were dealing with all human observers together, instead of with one alone. It would represent, therefore, in the second stage, the connected field 2's of all the observers concerned.

Along the lines of this universal field 2 network there would travel the *individual* field 1's. These last would be defined solely by the points where the lines in the travelling field 2 network intersected with corresponding lines in the similar but fixed network extending diagonally in Time 1 and Time 2, and composed of the connected diagonal reagents of the individuals in question.

Here we may depart from the essentials of our discussion so far as to glance at a rather interesting question. Is this field 2 *network*, with wide Space-gaps between its lines, the nearest approach to a universal field 2; or is there a field 2 which fills all Space, including those gaps?

Consider again the network of this universal, "family tree," cerebral substratum, a portion of which we may suppose to be exhibited, in perspective, by the connected lines AB, BC, and BD in Fig. 14.

These three lines will endure upwards in Time 2 in the forms of the planes AA'B'B, BB'C'C, and BB'D'D. These planes will be intersected by the respective reagents AE, EC', and ED',

and also by the respective field 2's (shown at the top of the figure, for simplicity)  $A'B'$ ,  $B'C'$ , and  $B'D'$ , constituting the portion of the field 2 network  $A'B'C'D'$ . Now, it is plain enough that the lines of the field 2 network must conform to the shape of the substratum figure. If, for example, when the field 2 network is at the bottom of the figure, intervention alters the trend of the substratum lines, so that  $B'C'$  and  $B'D'$  depart from

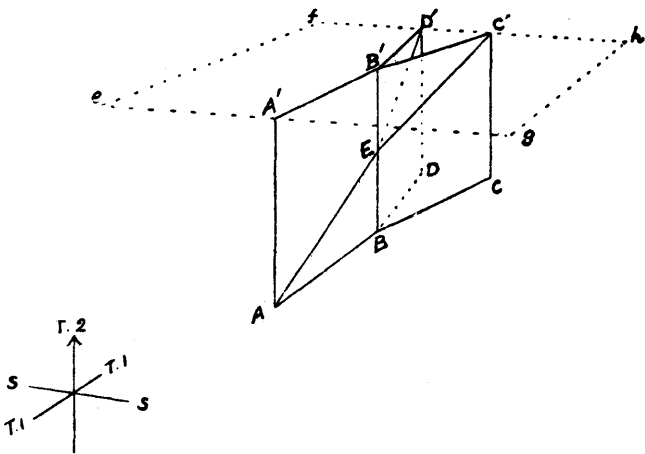

FIG. 14.

each other at a narrower angle than do  $BC$  and  $BD$ , then the corresponding field 2 lines must close up to conform. Otherwise we should have no field 1's at  $C'$  and  $D'$  when the field 2 network arrived at the top of the figure. But this conforming of the field 2 lines to the changing shape of the substratum figure can only be accounted for by regarding those lines as the *intersections of that substratum with a universal, Space-filling field 2* such as is represented by  $efgh$ . Similarly, there must be a

universal, Space-filling, diagonal reagent (not shown in the diagram, to avoid complications), whose intersections with the changeable substratum constitute the changeable individual reagents AE, EC', and ED'. And the place of intersection between this universal field 2 and this universal reagent must be a universal field 1, *fh*.\*

But now we have to ascertain why it is that each of these deflectable lines where the deflectable substratum is intersected by the universal field 2 should be conformed to throughout its deflections by a *particular* conscious observer 2 whose field 1 attention cannot move outside that shifting line. For this individual observer, be it remembered, is *not* the substratum contents of his field. The analysis has shown that he is an independent entity, who consciously observes, and, in a rudimentary way, interprets and thinks about, those substratum contents. Why, then, is he tied to them through all their spacial windings and through all their interventional changes in spacial position?

"Obviously," it may be replied, "because a travelling 'field of presentation' is merely a name for that part of an observable substratum which coincides with—is, so to say, covered by—the position of a travelling observer. The general, Space-filling field 2 is therefore the area covered by a general observer who observes everything that exists, and the individual conscious observers are merely places in that general observer where he happens to be intersected by those particular changing parts of the substratum which are the complex cerebra of living organisms."

\* So far as I can see, this field, in Relativity theory, would be an absolute field travelling over the Relativist's absolute substratum of point-events.

We must admit that this is indisputable so far as it goes, and we may note that, since the reagents are conscious only where they are intersected by that universal observer, and since the lines of intersection between the cerebral substrata and the universal observer may change within the area occupied by that observer, he must be capable of conferring consciousness anywhere within that area.

But all this does not completely answer our question. It tells us that the individual observers are merely parts of the general observer, but it does not plainly tell us why they are *individual*.

It is clear that the only things which confer *individuality* on those parts of the general observer which happen to be intersected by changing lines in the general network of the cerebral substratum are . . . those changing cerebral lines. Now, we have seen that the ultimate thinker in the series pertaining to each individual observer is learning to think in terms of mechanical brain-thinking. So the general observer must be, throughout his Space-filling area, the unknown element which lies at the bottom of consciousness and mind, and he is differentiating himself in certain widely separated places as a connected network of individual thinkers. We shall see, in a moment, what that implies.

But first we must note that the universal field 1, to which we referred earlier, will be, of course, the field 1 of the universal, Space-filling observer; for he must be just as serial as are the individual observers. He, with them,—for they are parts of him,—must be traceable up the series to one superlative general observer at infinity.

We may note here that the *individual* conscious observer comes into existence when the universal field 1 of this superlative observer reaches that

point in the network of the cerebral substratum (a "point-event") where the individual's body-line (a changeable line of probabilities) becomes distinct from the parent stem.

Now, since the field 2 of this superlative general observer embraces the Time 1 extension of the whole genealogically connected cerebral substratum, his attention must be capable of traversing that network throughout its whole Time 1 length.

Again, since he is the provider of consciousness to all those parts of himself which constitute the individual observers at infinity—and so the provider of their conscious observation—and since those individuals have, as we have ascertained, that ability to intervene which is a function of concentrated conscious observation (attention), we must regard this superlative observer as the ultimate provider of the individual's ability to intervene.

We may sum up, therefore, by saying that this superlative general observer is the fount of all that consciousness, intention, and intervention which underlies mere mechanical thinking; and that he, in his intersections with the cerebral substrata, is incarnate in all mundane conscious life-forms, in every dimension of Time; and that he must—owing to the unity of the network thus formed in himself and the ability of his attention to range over that network's full extent—contain in himself a distinct *personification* of all genealogically connected conscious life. And we may add that this "personification" must be capable of thinking on a scale rendered ampler than ours by the immense Time-range and Space-range of his field 2, and by the immense length of his experience as an "ultimate thinker" in that field.

We have wandered from our main task into what



appears to be a region for exploration by the theologian. Let us leave it to him (he will find an extraordinary number of *dicta* which fit the case), and get back to our proper business.

\* \* \* \* \*

Disciples of Nietzsche will note that cyclic-return theories (whether these be justified or unjustified) take on very different aspects when viewed in the light of Serialism. Assuming, for the sake of argument, that a return to *some* past configuration of the universe of matter occurs, it no longer follows that such return is a recommencement of a cycle similar to that which we are actually experiencing now. For intervention can operate towards the avoidance of unsatisfactory configurations. One result of such interference with the purely automatic sequence of events would be, of course, to increase enormously the length of the cycle. But the most important effect would be the shortening of this longest possible cycle into one which the interveners—general and particular—regarded as satisfactory.

Then, again, it must be borne in mind that similar corporeal configurations separated in Time 1 would pertain to different observer 2's—to different souls. (This would have pleased Marion Crawford.) And if there were repetitions, in Time 2, of the four-dimensional configurations of one of these observer 2's, those repetitions would, by analogy, pertain to different observer 3's (parts of our originally considered individual observer 3, in the same way that observer 2's separated in Time 1 are parts of a general observer of the field 2 network). And so on to infinity.

\* \* \* \* \*

This book is not intended to be anything more than a general introduction to Serialism as a theory of the universe. Every such theory must have its psychological, its physical, its theological, and its teleological aspects. At each of these we have glanced briefly, yet long enough to show us how large and how promising is the field for investigation

opened up by the new method of analysis. But exploration proper in these several regions has been regarded throughout as the province of specialists more directly concerned.

The man-in-the-street, however, will expect something in the nature of a summarized statement as to how he is to regard Serialism as affecting *himself*. Such statements are not always advisable—for reasons which will be clear enough to the judicially minded. But, in the present case, all the points which do directly affect the man-in-the-street have had to be touched upon in the course of the book, since it so happened that none of these points could be omitted from consideration without breaking off the argument at a critical place and leaving the theory, so-to-say, in the air. There can be no harm in summarizing in one place what has already been said in odd paragraphs throughout preceding pages.

Putting it roughly, then, I should say:

1. Serialism discloses the existence of a reasonable kind of "soul"—an individual soul which has a definite beginning in absolute Time—a soul whose immortality, being in other dimensions of Time, does not clash with the obvious ending of the individual in the physiologist's Time dimension, and a soul whose existence does not nullify the physiologist's discovery that brain activity provides the formal foundation of all mundane experience and of all associative thinking.

2. It shows that the nature of this soul and of its mental development provides us with a satisfactory answer to the "why" of evolution, of birth, of pain, of sleep, and of death.

3. It discloses the existence of a superlative general observer, the fount of all that consciousness, intention, and intervention which underlies mere

mechanical thinking, who contains within himself a less generalized observer who is the personification of all genealogically related life and who is capable of human-like thinking and prevision of a kind quite beyond our individual capabilities. In the superlative observer we individual observers, and that tree of which we are the branches, live and have our being. But there is no coming "absorption" for us; we are already absorbed, and the tendency is towards differentiation.

4. It points to the existence of a common-to-all field 1 filling all Space (not incompatible with Relativity theory). This would provide us with, at any rate, the primary essential for the production of anything in the nature of real telepathic inter-communication. Moreover, the inter-connection of the lines in the tree-like field 2 network seems to provide another kind of possibility in this respect.

# INDEX

## PART I

- AFTER-IMPRESSION, 12, 19, 20, 22  
Animism, 12, 13, 17, 26  
Association, 10, 23, 24, 25, 26, 27  
Attention, 16, 17, 23, 24, 27  
Automaton, 13  
  
Baldwin, Mark, 25, 27  
Body and mind, 12, 13  
Brain, 3, 4, 6, 7, 9, 10, 11, 12, 13,  
15, 16, 17, 24, 26  
Breathing, 16  
  
Cinema, 12  
Colour, 4, 5, 6, 7, 8, 9, 12, 18, 19,  
20  
Concept, 26, 27  
Concussion, 10  
Correlate, 10  
  
Dimension, 20  
Disposition, 17  
Dreams, 14, 25, 26  
  
Event, 21  
External reality, 11, 19, 25  
  
Field of consciousness, 15  
Field of presentation, 15, 16, 17  
  
Generic image, 22, 23, 24, 27  
  
Heat, 9  
  
Idea, 23, 26, 27  
Idealist, 12  
Ideas, train of, 21, 22, 24  
Illusion, 6  
Image, 17, 18, 21, 22, 23, 24, 25,  
26, 27; generic, 22, 23, 24, 27  
Impression, 17, 18, 19, 20, 21, 22,  
26; after-, 12, 19, 20, 22  
Integration, 25  
Intervention, 13, 17  
  
McDougall, William, 13  
Materialism, 26  
Mechanism, 9  
Memory, 10, 17, 18, 19, 20, 21, 22,  
25, 26  
Metaphysics, 10, 12  
Mind, mental, 8, 21, 23, 25, 28  
Mind and body, 12, 13  
  
Nerve, neural, 3, 7, 9, 10, 12, 13,  
17, 18, 25, 26  
  
Observer, observation, 11, 12, 13,  
16, 17, 18  
Order, 21  
  
Parallelism, 10, 12, 26  
Particle, 5, 7  
Phenomena, 6, 7, 8, 9, 10, 12, 15,  
16, 18, 19, 20, 25, 28  
Physics, 3, 4, 5, 6, 7, 8, 9  
Physiology, 16, 17, 24  
Presentation, 15, 16, 17; field of,  
15, 16, 17  
Pressure, 16  
Proof, 27  
Psychical, 8, 9, 10, 12, 16, 26  
Psychology, 8, 12, 15, 17, 19, 27  
Psychoneural, 10, 12, 26  
  
Realist, 12  
Reality, external, 11, 19, 25  
Reason, 25  
  
Science, 3, 8, 11, 13, 16, 27  
Sense, sensory, sensation, 7, 8, 9,  
10, 18  
Smell, 7, 8  
Soul, 13, 14  
Sound, 6, 7, 8, 9, 16, 19  
Spectra, 12  
Succession, 21  
Survival, 13

Taste, 7, 9  
 Thinking, 10  
 Time, 10  
 Train of ideas, 21, 22, 24  
 Universe, 7, 8, 11, 14

Vision, visual, 3, 4, 5, 6, 7, 8, 9,  
 12, 15, 18, 19, 20, 22  
 Ward, James, 5, 19, 22  
 Waves, electromagnetic, 3, 5, 9  
 Will, 18

## PART II

"Astral-wandering," 29, 37, 41  
 "Clairvoyance," 29, 31, 32, 37,  
 41  
 Dreams, examples of:  
 Aeroplane accident, 44 *et seq.*  
 Cape to Cairo expedition, 32  
*et seq.*  
 Factory fire, 39 *et seq.*  
 "Flying Scotsman," 46, 47  
 Horse, 41 *et seq.*  
 Martinique, 34 *et seq.*  
 War, 47

Dreams, examples of (*continued*):  
 Watch, 29 *et seq.*, 43  
 Dreams on wrong nights, 43  
 Identifying paramnesia, 37, 39,  
 41  
 Impressions, 43  
 "Messages from dead or dying,"  
 29, 37, 41, 44  
 Percepts, 43  
 Telepathy, 38, 41  
 Time, displacement in, 44

## PART III

Abnormality, 49, 54, 57, 75  
 Association, formation of, antici-  
 pated in dream, 90  
 Associational network, 54, 76 *et*  
*seq.*, 82, 88  
 Barrier between past and future,  
 54, 87, 88  
 Coincidence, 50, 51, 59, 60, 61, 68  
 Detail, importance of, 60, 64,  
 65; corroborative, 60, 63  
 Dreams, examples of:  
 Combination lock, 50, 51  
 Corwen meetings, 71, 72  
 Cows and gate, 69  
 "Dunne" aeroplane, 79, 80, 81  
 Fractured leg, 52  
 General Leman, 74  
 "German spy," 70  
 Ladder, 73  
 Lion-shooting, 77, 78  
 Painted boat, 72  
 Scooter, 78, 79  
 Secret loft, 67, 68  
 Silvertown explosion, 51

Dreams, examples of (*continued*):  
 Sparks, 62  
 Spilled ink, 76, 77  
 Two men and a dog, 67  
 Washing sails, 73  
 Wasp, 89, 90  
 Dreams, recalled by waking events,  
 52, 53, 56; leading up to the  
 cause of waking, 53; associated  
 with coming personal experi-  
 ences, 53; composition of, 54,  
 59; forgetting of, 50, 51, 56,  
 64, 65; difficulty of associating  
 with subsequent event, 62, 63;  
 range of, 82  
 "Happening before," 53, 75  
 Images, proportion of past to  
 future in dreams, 54, 82  
 Integration, 63, 69, 90  
 "Present moment," travelling,  
 54  
 Relativity, 76

- Society for Psychological Research, 53  
 Space-time, 50  
 Time, as fourth dimension, 49, 54; without parts, 50; "mixed," 50; unidimensional, 57; absolute, 57; order, 62; man's relationship to, 68; two-dimensional, 76  
 Waking experiments, 83 *et seq.*

PART IV

- Analytical devices, 116  
 Bergson, 114, 117, 118, 119, 120, 121  
 Brain states, their relation to future, 93, 94  
 Clocks, travelling in, or extending in time, 111  
 D'Alembert, 99  
 Dimension, 99; definition of, 100, 101  
 Economy of hypotheses, 117, 119  
 Eddington's views, 109  
 Einstein's theory, 108  
 Events, 113; objective, observed in succession, 114, 115, 116  
 Explanation, limiting conditions of our, 91, 92  
 Extension, prior to dimensions, 106, 107, 108, 109, 110  
 Field of observation, travelling, 96, 97, 98, 100, 104, 110, 114, 115, 116  
 Freewill, 92  
 Hinton's theory, 99 *et seq.*  
 Hypotheses, economy of, 117, 119  
 Intervention, 91, 92  
 Man-in-the-street's notion, 95 *et seq.*  
 Matter, in relativity theory, 112  
 Memory train, ends at present moment, 92; in Bergson's theory, 121  
 Minkowski's world, 108  
 Motion, absolute and apparent, 103, 104  
 Observer, indefinite in Relativity, 110, 111  
 Observer's world-line, 107, 108, 109, 110, 111; direction of, 108, 109, 110, 114  
 Order, 98; yet disorder 1, 91  
 Parallelism, psychoneural, 92  
 Premises adopted by author, 113, 114; by reader in all practical questions involving time, 116  
 "Reality," relativity of, 92; time's length as, 116  
 Relativity, 93, 108, 109, 110, 111, 112, 114  
 Space-time, 97, 106, 107, 108 *et seq.*  
 Successive observation of objective events (see "Field of observation")  
 Target illustration, 93, 94  
 Time, infinite regress of, 96, 104, 108, 111, 120; models of, 97, 98; origin of conception or perception of, 98, 99; empty, 104, 105, 114; as an analytical device, 116; as a growing "past," 117, 118, 119, 120, 121  
 "Time machine," 106, 107, 108  
 Terms, questions and answers in, 116  
 Track, 109, 110, 111, 112  
 Wells's theory, 106, 107, 108  
 Wildon Carr, 120, 121  
 World-line, 99, 102, 103, 104, 106, 107, 108, 109 *et seq.*, 114, 115

## PART V

- Action, 159, 192 *et seq.*; and probability, Eddington's identification, 195
- Animus, 164
- Attention, movable within field of presentation, 128, 134, 135, 145, 146; serial law of, 154, 159, 161, 162, 178, 179; dream wandering of, 159, 160, 161, 168, 169; a matter of habit, 161, 162, 171, 176; and intensity, 169, 170; and intelligibility, 177; why habitually directed to field 1, 176, 177; employed in intervention, 167, 178, 179, 184; connection with "context," 173, 174; of the superlative and the synthetic observers, 205, 208
- Association, serialism in, 168, 172, 173, 174
- Birth of conscious individual, 204, 205
- Brain as teacher of the mind, 175, 176, 204
- Consciousness, serialism of, 155, 156, 157; law of, 153; self-, 157; provided by superlative observer, 204, 205, 207
- Context, 173, 174
- Crawford, Marion, 206
- Death, 162, 163; value of, 180, 181
- Disagreeableness, discomfort, 169, 170
- Dream effect, explanation of, 159, 160, 161
- Dreams, ordinary, 166 *et seq.*; waking interferences with, 168, 169; of savages, 164
- Eddington, 127, 193, 194, 195, 196
- Endurance of phenomena, 130; of ultimate physical correlates, 131
- Evolution, 176
- Field of presentation, definition of, 145, 146; law of serial field, 151; as necessary starting-point, 128, 129; fixed with regard to observer, 128, 136; a unique place in any temporal dimension, 131, 132, 134
- Field 1, interferences with dreams, 168, 169; space-filling, 198, 203, 204
- Field 2, space-filling, 201 *et seq.*; network of individual observers in, 200 *et seq.*
- Fields of different observers, how related, 199 *et seq.*
- "Freewill," 179
- Frequency, 159
- Habit, 161, 162, 171; referable to ultimate observer, 175; origin of attention to field 1, 176, 177
- Half-steps in the analysis, 131, 133, 134
- Incarnation (see "Observer, synthetic")
- Integration, 168
- Intensity of sensation dependent upon concentration, 169, 170
- Interpretations (see "Meanings")
- Intervention, 167, 177, 178, 179, 182 *et seq.*, 199, 202, 205, 207; empirical proof of, 165
- Jones, 186 *et seq.*
- Law of serial fields, 151; of serial observer and serial consciousness, 151, 152, 153; of serial attention, 154
- McDougall, William, 173, 174
- McKendrick, 176
- Materialism, 136
- Meanings, 168, 171, 172, 173, 174, 175, 177, 180
- Memory, serialism of, 166, 171, 172, 173
- Mind, education of, 175, 176, 204; serialism of, 177, 178
- Moore, J. S., 173, 174
- Motion, apparent, 127, 128, 129, 131, 133, 134, 135, 167

- Network, field 2, of individual observers, 200 *et seq.*
- Nietzsche's "return" theory, 206
- Observer, serial, law of, 151, 152, 153; as thinker, 185, 186, 190, 191; synthetic, embracing all individual observers and contained in superlative observer, 205, 208; superlative, space-filling, 203 *et seq.*
- Observers, different individual, how their fields are related, 199 *et seq.*
- Pain, 169, 170; as educative agent by attracting attention to field 1, 177
- Path, absolute, 151, 185, 198
- Physics, serialism in, 195, 196
- Probability, 185, 193, 194; Eddington's identification with action, 194, 195, 196
- Quantum, 192 *et seq.*
- Railway train illustrations, 127, 128
- Reagent, definition of, 141, 142; temporal endurance of number 1, 140, 149; serialism of, 150, 155, 191
- Reagent 1, universal, space-filling, 203
- Relation, between terms of a series, 123, 124, 142, 147, 162, 163, 190, 191; between different observers' fields, 199 *et seq.*
- Relativity, 131, 132, 133, 192, 197, 198; problem treated serially, 198
- "Return theory," 206
- Serialism, 197, 198, 200, 206
- Series, definition of, 123; relation between terms of, 123, 124, 142, 147, 162, 163, 190, 191; first-term of, is lop-sided, 124, 162, 163; "Chinese boxes" type of, 151
- Sleep, value to mind, 180, 181
- Space dimensions, criterion of, 137, 143, 144
- Space, serial, 139, 144, 148
- Superlative observer, 203 *et seq.*
- Super-observer (see Synthetic observer)
- Survival, 162, 163
- Synthetic observer, 205, 208
- Thinker (thinking), 165, 166, 168, 171, 172, 173, 174, 175, 176, 180, 182, 184; ultimate, 185, 186, 190, 191; and superlative observer, 204 *et seq.*; of synthetic observer, 205, 208
- Time, activity of or in, involves infinite regress, 124, 125; neglect to examine regress of, 124, 125; our awareness of, 157, 158; absolute, 151
- Time dimension, definition of, 136, 137, 143; travelling in, takes absolute time, 124, 137, 148; in one term is space dimension in the next, 139, 144, 148; arrangement of time dimensions in series differs from arrangement in parallel, 143
- Waking experiment, 161; as evidence of possibility of "free-will," 179



## SOME PRESS NOTICES OF THE FIRST EDITION

H. G. WELLS in *The Sunday Express*.

. . . I find it a fantastically interesting book. It has stirred my imagination vividly, and I think most imaginative people will be stirred by the queer things he has advanced in it. I do not think it has yet been given nearly enough attention.

*The Outline.*

The day may come—will probably come—when the world will consider this as the most important book of our age. There are many people even now, who say that it will revolutionize our attitude towards the world we live in much as did the "Origin of Species."

*The Observer.*

It is no use for Mr. Dunne to hide his light under the bushel of his title: for his bushel contains full measure of well-observed fact . . . an admirably clean and bright statement of both his data and his reasoning.

C. E. M. JOAD in *The Spectator*.

Exceedingly well, even wittily written . . . it can be recommended to everybody who wishes to learn how to anticipate his own future.

*Oxford Magazine.*

Mr. Dunne is a writer of great charm and humour—admirable qualities in a metaphysician; and his knowledge of the subject is surely as great as his knowledge of the stability of aeroplanes.

PROF. HYMAN LEVY in *Nature*.

A careful, sane experimenter quite alive to the dangers and pitfalls that may beset an observer in a strange field. . . . If this work is not a practical joke, and it does not sound like it, and if the author is sane, and there is ample contributory evidence of this, the subject he has opened up ought to be examined.

*The Times.*

The statements are of so serious and remarkable a character that it is certainly worth while for a large number of people to carry out the necessary experiments . . . whatever we may think of Mr. Dunne's own philosophy of Time it is certain that something almost equally strange is necessary to account for his results.

DR. F. C. S. SCHILLER, F.B.A., in *The Hibbert Journal*.

This is a book well calculated to flutter the dovescotes, or rather rookeries, of the philosophers . . . he has raised stimulating questions with which any philosophy which is not utterly effete should feel it its duty to grapple.

PROF. J. L. STOCKS in *The London Mercury*.

The sensation of the past philosophical year was undoubtedly Mr. Dunne's "Experiment with Time." The book was not only surprising and provocative in its conclusions; it surprised not less by the skill with which it unfolded and developed its thesis. It certainly provided the best reading which the philosophical public has enjoyed for several years. . . . We hope we have not heard the last of Mr. Dunne.

*The Warrington Examiner*.

This is an enthralling book . . . is within the range of thousands of readers of moderate education and intelligence . . . it is a delightful book to read. Whether we have here a new Descartes or not, the possibility that we have forbids us to ignore Mr. Dunne.

*The Times of India*.

One of the most momentous books of the present era. . . . "An Experiment with Time" produces in the reader such a sense of exaltation that one feels on the verge of a new birth. . . . It is typical of, but in advance of, much that has been written in recent years from Bergson and Einstein to Eddington and J. W. Sullivan.

## TWO AMERICAN PRESS NOTICES

*Saturday Review of Literature*.

So startling in its apparent conclusions and in its nature so unusual that I fear it may be passed over as pseudo-science by those who look only at its jacket. . . . I have given it to two experts who have confirmed my own quite unofficial view that it is as important as it is surprising.

*The Times (New York)*.

It will probably take more than one reading for the student to familiarize himself with the new and vast horizons opened to his speculative gaze. But the effort will be well worth while. For in linking, by implication, Einstein with Berkeley, and the experimental physiologist with the believer in the immortality of the soul, the author of "An Experiment with Time" has evolved a "Weltanschauung" profoundly stirring and fascinating in its implications.

AN  
EXPERIMENT  
WITH  
TIME

▼  
J.W.DUNNE.

SECOND  
EDITION

BLACK